



*Jacuzzi*

## J-300<sup>TM</sup> Collection

Owner's Manual

[Rev A](#)

J-385<sup>TM</sup>

J-335<sup>TM</sup>

J-375<sup>TM</sup>

J-325<sup>TM</sup>

J-365<sup>TM</sup>

J-315<sup>TM</sup>

J-355<sup>TM</sup>

J-345<sup>TM</sup>

# Attention New Spa Owner!

Congratulations on the purchase of your new Jacuzzi® spa! The following is a list of automated functions performed by your spa. These functions are listed below in an attempt to alleviate any operational concerns you may have during the first 24 hours of ownership! Also listed below are important maintenance recommendations you should observe on a regular basis to protect your new investment.

## Automated Operations

Your new spa is equipped with an automated “clean-up” cycle that clears all plumbing lines daily to promote maximum water sanitation. Each day at 12:00 PM (noon), each pump will activate and run for one minute. If either pump has just finished a 20 minute time out, it will not automatically activate for the clean-up cycle.

**Note:** Turning off the corresponding jets pump that is running can deactivate the feature.

## Maintain Healthy Spa Water

Always maintain your spa’s water chemistry within the following parameters:

	With ClearRay®	Without ClearRay®
pH	7.4-7.6	7.4-7.6
Free Chlorine	no less than 1.0 ppm	3.0-4.0 ppm
Free Bromine	no less than 2.0 ppm	2.0-4.0 ppm
Total Alkalinity	100-150 ppm	100-150 ppm
Calcium Hardness	150-250 ppm	150-250 ppm

**IMPORTANT:** ClearRay Active Oxygen® system is factory installed. If the ClearRay Active Oxygen® system is altered or is not operating efficiently then follow the “without ClearRay®” water chemistry parameters as defined by the Pool & Hot Tub Alliance. ClearRay® Unit requires an annual bulb replacement to operate properly.



**TO DECREASE RISK OF INFECTION OR DISEASE!** Always maintain your spas filter as outlined below to ensure healthy spa water. Refer page 56 “Water Quality Maintenance” for additional information.

## Required Filter Maintenance

Your new spa is equipped with an advanced water filtration system that provides unsurpassed water quality! To ensure maximum water quality at all times, you should clean both filter cartridges every month, or earlier as necessary. See page 49 for detailed filter cartridge cleaning/replacement instructions.

## Required Water Replacement



**TO DECREASE RISK OF INFECTION OR DISEASE!** You should replace the spa’s water every 3 months. The frequency depends on a number of variables including frequency of use, number of users, and attention paid to water quality maintenance. You will know it is time for a change when you cannot control sudsing and/or you can no longer get the normal feel or sparkle to the water, even though the key water balance measurements are all within the proper parameters. See page 56 for additional information.

\*\*Specifications and operations subject to change without notice.\*\*

# Table of Contents

<b>1.0</b>	<b><i>Important Spa Owner Information</i></b> .....	<b>1</b>
<b>2.0</b>	<b><i>FCC Notice</i></b> .....	<b>1</b>
<b>3.0</b>	<b><i>Important Safety Instructions for all Spa Owners</i></b> .....	<b>2</b>
3.1	<i>Entrapment Risk</i> .....	6
3.2	<i>Hyperthermia</i> .....	7
3.3	<i>Important Additional Safety Instructions</i> .....	8
3.4	<i>PRECAUTIONS-Important Chemical Safety</i> .....	8
3.5	<i>PRECAUTIONS FOR USE OF PRODUCTS CONTAINING SODIUM BROMIDE</i> .....	8
<b>4.0</b>	<b><i>Choosing A Location</i></b> .....	<b>9</b>
4.1	<i>Outdoor Location</i> .....	10
4.2	<i>Indoor Location</i> .....	10
<b>5.0</b>	<b><i>General Electrical Safety Instructions</i></b> .....	<b>11</b>
<b>6.0</b>	<b><i>Power Requirements</i></b> .....	<b>12</b>
6.1	<i>2-Pump 240V Power Requirements</i> .....	12
6.2	<i>Dedicated 3-Wire 240V J315/J325 Power Requirements</i> .....	13
6.3	<i>Convertible 120V/240V J315/J325 Power Requirements</i> .....	13
<b>7.0</b>	<b><i>Electrical Wiring Instructions</i></b> .....	<b>14</b>
<b>8.0</b>	<b><i>Spa Fill Up Procedure</i></b> .....	<b>19</b>
<b>9.0</b>	<b><i>General Spa Features and Controls</i></b> .....	<b>24</b>
<b>10.0</b>	<b><i>Operating Instructions</i></b> .....	<b>25</b>
10.1	<i>Register Your New Spa</i> .....	25
10.2	<i>Control Panel</i> .....	26
10.3	<i>Activate Jet Pumps</i> .....	28
10.4	<i>Activating the Lights</i> .....	29
10.5	<i>Jets</i> .....	30
10.6	<i>Selecting Desired Massage Action</i> .....	30
10.7	<i>HydroSoothe™ Valve Control</i> .....	30
10.8	<i>Waterfall Feature</i> .....	30
10.9	<i>ClearRay on Demand (Standard Models)</i> .....	31
10.10	<i>Air Controls</i> .....	31
10.11	<i>Optional BLUEWAVE® Spa Stereo System</i> .....	31
10.12	<i>Cleanup Cycle</i> .....	31
10.13	<i>Optional SmartTub® System</i> .....	31
10.14	<i>Exterior Lights</i> .....	32
10.15	<i>IR and Red Light Therapy</i> .....	33

<b>11.0</b>	<b>Menu Features and Programming Instructions .....</b>	<b>34</b>
11.1	Programming the Heat Settings .....	35
11.2	Programming the Primary Filtration .....	36
11.3	Programming the Secondary Filtration .....	37
11.4	Programming the Time .....	38
11.5	Programming the Date .....	38
11.6	Water Care Programming .....	39
11.7	Locking the Spa .....	41
11.8	Unit Display .....	42
11.9	Programming the Language .....	42
11.10	Programming the Panel .....	43
11.11	Diagnostic Menu .....	43
11.12	Programming the Optional True™ Water Care Filtration .....	44
11.13	Programming the Optional True Water Care Reminders .....	46
<b>12.0</b>	<b>Spa Maintenance .....</b>	<b>48</b>
12.1	Cleaning The Filters .....	49
12.2	Draining and Refilling .....	51
12.3	Pillow Care .....	52
12.4	Cleaning The Spa Interior .....	52
12.5	Cover Care and Maintenance .....	53
12.6	Tool Free Access Door .....	54
12.7	Maintaining the Spa Cabinet .....	54
12.8	Winterizing .....	54
12.9	Restarting Your Spa in Cold Weather .....	56
<b>13.0</b>	<b>Water Quality Maintenance .....</b>	<b>56</b>
13.1	pH Control .....	56
13.2	Sanitizing .....	57
13.3	ClearRay Active Oxygen® System .....	57
13.4	ClearRay® Bulb Replacement and Quartz Tube Maintenance .....	58
<b>14.0</b>	<b>Error Conditions/Error Messages .....</b>	<b>61</b>
<b>15.0</b>	<b>Troubleshooting Procedures .....</b>	<b>64</b>
15.1	Flow issues .....	64
15.2	None of the Components Operate (e.g. Pump, Light) .....	64
15.3	Pump Does Not Operate .....	64
15.4	Poor Jet Action .....	65
15.5	Water is Too Hot .....	65
15.6	No Heat .....	65



<b>16.0</b>	<b>Circuit Board Diagrams.....</b>	<b>66</b>
16.1	<i>J-335, J-345, J-355, J-365, J-375 and J-385 Dedicated Power Models (60 Hz).....</i>	66
16.2	<i>J-315 and J-325 3-Wire 240V 60Hz Dedicated Power Models.....</i>	67
16.3	<i>J-315 and J-325 Convertible Power Models (For a 3-wire 120V 60 Hz connection).....</i>	68
16.4	<i>J-315 and J-325 Convertible Power Models (For a 4-wire 240V 60 Hz connection).....</i>	69
<b>17.0</b>	<b>Dip Switch Settings and Wiring.....</b>	<b>70</b>
17.1	<i>Switch settings for Domestic 60Hz Models .....</i>	70
<b>18.0</b>	<b>Optional BLUEWAVE® Spa Stereo System.....</b>	<b>72</b>
18.1	<i>Electronic Device Connections and Functions .....</i>	72
18.2	<i>Stereo Cautions.....</i>	72



## **1.0 Important Spa Owner Information**

Your Jacuzzi J-300™ Collection spa is constructed to the highest standards and is capable of providing many years of trouble-free use. However, because heat retentive materials are utilized to insulate the spa for efficient operation, an uncovered spa surface and wall fittings directly exposed to sunlight and high temperatures for an extended period are subject to permanent damage. Damage caused by exposing the spa to this abuse is not covered under warranty. We recommend that you always keep the spa full of water when it is exposed to direct sunlight and that you keep the Jacuzzi premium insulating cover in place at all times when the spa is not in use. Read and carefully follow the requirements for your spa's support base found in Section 4.0 titled, "Choosing A Location" (page 9).

**Jacuzzi constantly strives to offer the finest spas available, therefore modifications and enhancements may be made which affect the specifications, illustrations and/or instructions contained herein.**

## **2.0 FCC Notice**



This equipment has been tested and found to comply with the limits for a Class B Digital Device, pursuant to Part 15 of the FCC Rules. These limits are designed to provide reasonable protection against harmful interference in a residential installation. This equipment generates, uses and can radiate radio frequency energy and, if not installed and used in accordance with the instructions, may cause harmful interference to radio communications. However, there is no guarantee that interference will not occur in a particular installation. If this equipment does cause harmful interference to radio or television reception, which can be determined by turning the equipment off and on, the user is encouraged to try to correct the interference by one or more of the following measures:

1. Rearrange or relocate the receiving antenna.
2. Increase the separation between the equipment and receiver.
3. Connect the equipment into an outlet on a circuit different from the circuit connected.
4. Consult the dealer or an experienced radio/TV technician for help. Changes or modifications not expressly approved by the party responsible for FCC compliance could void the user's authority to operate this equipment.

### **3.0 Important Safety Instructions for all Spa Owners**

#### **READ AND FOLLOW ALL INSTRUCTIONS CAREFULLY!**

This spa was manufactured to meet the standards and specifications outlined in the “Virginia Graeme Baker Pool and Spa Safety Act” (VGB Safety Act). When installing and using this spa, basic safety precautions should always be followed, including:

1.  **DANGER: RISK OF SEVERE INJURY OR DROWNING!**
  - Extreme caution must be exercised to prevent unauthorized access by children.
  - To avoid accidents, ensure that children do not use this spa unless supervised at all times. Adult supervision is a critical safety factor in preventing children from drowning.
  - Use the straps and clip tie downs to secure the spa cover when not in use. This will help discourage unsupervised children from entering the spa. Keep the spa cover secure in high-wind conditions.
  - There is no representation that the cover, clip tie-downs, or actual locks will prevent access to the spa.
  
2.  **DANGER: RISK OF SEVERE INJURY OR DROWNING!**
  - Keep hair, loose articles of clothing or hanging jewelry away from suction fittings, rotating jets or other moving components to avoid entrapment that could lead to drowning or severe injury.
  - Never use the spa unless all suction guards, filter, filter lid, or skimmer assembly are installed to prevent body and/or hair entrapment.
  - Never operate or use the spa if the filter, filter lid, or skimmer assembly are broken or any part of the skimmer assembly is missing. Please contact your dealer or nearest service center for service.
  - The suction fittings and suction covers in this spa are sized to match the specific water flow created by the pump(s). If it is necessary to replace the suction fittings, suction covers or pump(s), be sure that the flow rates are compatible and are in compliance with the VGB Safety Act.
  - Never replace a suction fitting or suction cover with one rated less than the flow rate marked on the original suction fitting. Using improper suction fittings or suction covers can create a body or hair suction entrapment hazard that may lead to drowning or severe injury.
  
3.  **DANGER: RISK OF SEVERE INJURY FROM ELECTRIC SHOCK OR DEATH FROM ELECTROCUTION!**
  - Install the spa at least 5 feet (1.5m), from all metal surfaces. As an alternative, a spa may be installed within 5 feet of metal surfaces if each metal surface is permanently connected (bonded) by a minimum No. 8 AWG (8.4 mm<sup>2</sup>) solid copper conductor attached to the wire connector on the grounding lug, inside the equipment compartment on the equipment box.



- A grounding wire connector is provided on this unit to connect a minimum No. 8 AWG (8.4 mm<sup>2</sup>) solid copper conductor between this unit and any metal equipment, metal enclosures of electrical equipment, metal water pipe, or conduit within 5 feet (1.5m) of the unit.
- Never permit any electrical appliance, such as a light, telephone, radio, television, etc. within 5 feet (1.5m) of a spa unless such appliances are built-in by the manufacturer.
- Never bring any electrical appliances into or near the spa.
- Never operate any electrical appliances from inside the spa or when you are wet.
- The electrical supply for this product must include a suitably rated switch or circuit breaker to open all ungrounded supply conductors to comply with article 422.20 of the National Electrical Code/USA, ANSI/NFPA 70. The disconnecting means must be readily accessible and visible to the spa occupant but installed at least 5 feet (1.5m), from the spa.
- The electrical circuit supplied for the hot tub must include a suitable ground fault circuit interrupter (GFCI) as required by NEC Article 680.42.



4.  **WARNING: RISK OF SEVERE INJURY OR DEATH!**

- Extreme caution must be exercised to prevent diving or jumping into the spa or slipping and falling, which could result in unconsciousness, drowning, or serious injury. Remember that wet surfaces can be very slippery.
- Never stand, walk or sit on the top railing of the spa.

5.  **WARNING: RISK OF HYPERTHERMIA (OVER-HEATING) CAUSING SEVERE INJURY, BURNS, WELTS OR DEATH!**

- Water temperature in excess of 104°F (40°C) may be injurious to your health.
- Refer to Section 3.2 Hypertthermia for specific causes and symptoms of this condition.
- The water in the spa should never exceed 104°F (40°C). Water temperatures between 100°F (38°C) and 104°F (40°C) are considered safe for a healthy adult.
- Lower water temperatures are recommended for young children (children are especially sensitive to hot water) and when spa use may exceed 10 minutes.
- The Consumer Products Safety Commission/USA has stated that the water temperature in a spa should not exceed 104°F (40°C).
- Always test the spa water temperature before entering the spa. The user should measure the water temperature with an accurate thermometer since the tolerance of water temperature-regulating devices may vary as much as +/- 5°F (2°C).

6.  **WARNING: RISK OF SEVERE INJURY OR DEATH!**
- Since excessive water temperatures have a high potential for causing fetal damage during the early months of pregnancy, if pregnant or possibly pregnant, consult your physician before using a spa.
  - Pregnant or possibly pregnant women should limit spa water temperatures to 100°F (38°C).
  - Persons suffering from obesity or a medical history of heart disease, low or high blood pressure, circulatory system problems, diabetes, infectious diseases or immune deficiency syndromes should consult a physician before using a spa.
  - If you experience breathing difficulties in association with using or operating your spa, discontinue use and consult your physician.
  - Persons using medication should consult a physician before using a spa since some medication may induce drowsiness, while other medication may affect heart rate, blood pressure, and circulation.
  - Persons suffering from any condition requiring medical treatment, the elderly, or infants should consult with a physician before using a spa.
  - The use of alcohol, drugs, or medication before or during spa use may lead to unconsciousness with the possibility of drowning.
7.  **WARNING: RISK OF SEVERE INJURY OR DEATH!**
- Prolonged immersion in a spa may be injurious to your health.
  - Observe a reasonable time limit when using the spa. Exposures at higher temperatures can cause high body temperature (overheating). Symptoms may include dizziness, nausea, fainting, drowsiness, and reduced awareness. These effects could possibly result in drowning or serious injury.
  - Never use a spa immediately following strenuous exercise. Enter and exit the spa slowly. Wet surfaces can be slippery.
8.  **WARNING: TO DECREASE RISK OF INFECTION OR DISEASE!**
- To reduce the risk of contracting a waterborne illness (e.g. an infection, bacteria or virus) and/or respiratory ailments, maintain water chemistry within the parameters listed on the inside cover of this manual and consult with a licensed engineer regarding proper ventilation if installed indoors or in an enclosed area.
  - People with infectious diseases should not use a spa to avoid water contamination, which could result in spreading infections to others.
  - Always shower before and after using your spa. Maintain water chemistry in accordance with manufacturer's instructions. Failure to do so may result in contracting a waterborne illness (e.g. an infection, bacteria or virus).

9.  **WARNING:** In addition to maintenance of filters and water chemistry, proper ventilation is recommended to reduce the risk of contracting a waterborne illness (e.g. an infection, bacteria or virus) and/or respiratory ailments that could be present in the air or water. Consult a licensed architect or building contractor to determine your specific needs if installing your hot tub indoors.
10. **CAUTION: TO DECREASE RISK OF PRODUCT DAMAGE.**
- Maintain water chemistry in accordance with manufacturer's instructions.
  - Proper chemical maintenance of spa water is necessary to maintain safe water and prevent possible damage to spa components.
11.  **WARNING: RISK OF SEVERE INJURY OR DEATH!** The appliance is not intended for use by persons (including children) with reduced physical, sensory or mental capabilities, or lack of experience or knowledge, unless they have been given supervision or instruction concerning use of the appliance by a person responsible for their safety.
12. **NOTE:** This spa is not intended nor designed to be used in a commercial or public application. The spa buyer shall determine whether there are any code restrictions on the use or installation of this spa since local code requirements vary from one locality to another.

## Hot Tub Safety

To ensure you have a safe and enjoyable hot tub experience, learn all you can about hot tub safety and emergency procedures.

The Pool & Hot Tub Alliance has a great source of safety literature.

- Go to <http://phta.org>
- Conduct your own search on the internet
- Write to the following address:

Pool & Hot Tub Alliance  
2111 Eisenhower Avenue  
Alexandria VA 22314  
703.838.0083

## Proposition 65 (FOR CALIFORNIA RESIDENTS ONLY)



**WARNING:** Cancer and Reproductive Harm  
[www.p65Warnings.ca.gov](http://www.p65Warnings.ca.gov)

## J-300

### 3.1 Entrapment Risk

The Consumer Products Safety Commission/USA has reported that users of pools and spas have become entrapped (stuck) to drain and/or suction fittings causing death, drowning, or serious injury (see diagram below). This spa was manufactured to meet the standards and specifications outlined in the "Virginia Graeme Baker Pool and Spa Safety Act" (VGB Safety Act). Entrapment risk can be minimized if proper precautions are taken.



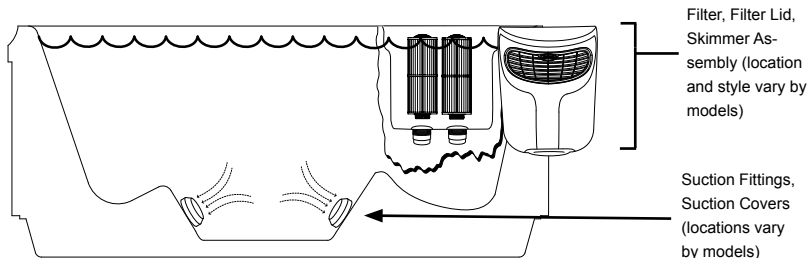

#### **DANGER: RISK OF PERSONAL INJURY OR DEATH!**

Never operate the spa if a suction fitting, suction cover, filter, filter lid or skimmer assembly are broken, damaged or missing.





**Note: Suction covers must be replaced every 7 years.**

- 1.  DANGER: RISK OF SEVERE INJURY OR DROWNING!**  
**Hair entrapment:** May occur if hair is entangled, knotted or snagged in a drain suction or skimmer assembly. This has been reported in persons who when submerge themselves underwater, allowing hair to come close and/or within the reach of the suction fittings, suction covers or skimmer assembly.

  - Keep hair away from suction fittings, suction covers, filter, filter lid or skimmer assembly.
  - Children are at risk for hair entrapment if swimming under water.
  - Never allow children to play or get near the suction fittings, suction covers, filter, filter lid or skimmer assembly.
- 2.  DANGER: RISK OF SEVERE INJURY OR DROWNING!**  
**Limb entrapment:** May occur when a limb becomes entrapped, inserted or sucked into a suction or outlet opening.

  - Always keep suction fittings, suction covers, filter, filter lid or skimmer assembly in place when operating to avoid limb entrapment.
  - Never allow children to play or get near the suction fittings, suction covers, filter, filter lid or skimmer assembly.



3.  **DANGER: RISK OF SEVERE INJURY OR DROWNING!**  
**Body entrapment:** May occur when part of the torso becomes entrapped, inserted or sucked into a suction or outlet opening.
- Never allow children to play or get near the suction fittings, suction covers, filter, filter lid or skimmer assembly.
4.  **DANGER: RISK OF SEVERE INJURY OR DROWNING!**  
**Evisceration (disembowelment) entrapment:** May occur when the buttock becomes entrapped, inserted or sucked into a suction or outlet opening.
- Never sit on suction fittings, suction covers, filter, filter lid or skimmer assembly.
  - Never allow children to play or get near the suction fittings, suction covers, filter, filter lid or skimmer assembly.
5.  **DANGER: RISK OF SEVERE INJURY OR DROWNING!**  
**Mechanical entrapment:** May occur when jewelry, swimsuit, or hair accessories become entangled, knotted or snagged in a drain suction or skimmer assembly.
- Never allow your jewelry, swimsuit, or hair accessories to come close to the suction fittings, suction covers or skimmer assembly.
  - Never allow children to play or get near the suction fittings, suction covers, filter, filter lid or skimmer assembly.

### 3.2 Hyperthermia

Prolonged immersion in hot water may induce hyperthermia (overheating). The use of alcohol or drugs can greatly increase the risk of fatal hyperthermia in spas. A description of the causes, symptoms, and effects of hyperthermia are as follows:

Hyperthermia occurs when the internal temperature of the body reaches a level several degrees above the normal body temperature of 98.6°F (37°C). The symptoms of hyperthermia include drowsiness, lethargy (fatigue), and an increase in the internal temperature of the body (feeling of being too hot). The effects of hyperthermia include:

- Unawareness of impending hazard;
- Failure to perceive heat;
- Failure to recognize the need to exit spa;
- Physical inability to exit spa;
- Fetal damage in pregnant women; and
- Unconsciousness and DANGER of drowning.

A Warning Sign is provided in your warranty packet. Please install at a location near your spa, where it is visible to users of the spa. For additional or replacement Warning Signs please contact your local Jacuzzi dealer and reference item number #6530-082.

## **J-300**

### **3.3 Important Additional Safety Instructions**

When using this electrical equipment, basic safety precautions should always be followed, including the following:

- 1. READ AND FOLLOW ALL INSTRUCTIONS.**
- A green colored terminal or a terminal marked G, Gr, Ground, Grounding or the  $\oplus$  symbol\* is located inside the supply terminal box or compartment. To reduce the risk of electric shock, this terminal must be connected to the grounding means provided in the electric supply service panel with a continuous copper wire equivalent in size to the circuit conductors that supply this equipment (\*IEC Publication 417, Symbol 5019).
- At least two lugs marked "Bonding Lugs" are provided on the external surface or on the inside of the supply terminal box/ compartment. To reduce the risk of electric shock, connect the local common bonding grid in the area of the spa to these terminals with an insulated or bare copper conductor not smaller than No. 6 AWG (10 mm<sup>2</sup>).
- All field installed metal components such as rails, ladders, drains or other similar hardware within 10 feet (3m) of the spa shall be bonded to the equipment grounding buss with copper conductors not smaller than No. 6 AWG (10 mm<sup>2</sup>).
- 5. SAVE THESE INSTRUCTIONS.**

### **3.4 PRECAUTIONS-Important Chemical Safety**

Do not use this device with bromide products.

### **3.5 PRECAUTIONS FOR USE OF PRODUCTS CONTAINING SODIUM BROMIDE**

- Do not use any Product containing Sodium Bromide with an electrolysis device (for example, a chlorine generator).
- Do not use any Product containing Sodium Bromide with ozonation.
- Do not use any Product containing Sodium Bromide with ultraviolet (UV).

## 4.0 Choosing A Location

**IMPORTANT:** Because of the combined weight of the spa, water and users, it is extremely important that the base upon which the spa rests be smooth, flat, level and capable of uniformly supporting this weight, without shifting or settling, for the entire time the spa is in place. Visit [www.Jacuzzi.com](http://www.Jacuzzi.com) for information. If the spa is placed on a surface which does not meet these requirements, damage to the skirt and/or the spa shell may result. Damage caused by improper support is not covered under warranty. It is the responsibility of the spa owner to assure the integrity of the support over time. We recommend a poured, reinforced concrete slab with a minimum thickness of 4 inches (10 cm). Wood decking is also acceptable provided it is constructed so that it meets the requirements outlined above.



**WARNING:** For spas that are to rest on balconies, roofs or other platforms not specifically tied into main structural support, consult a professional Structural Engineer with experience in this type of application.



**WARNING:** Proper drainage is required. The installation must not allow the spa equipment bay to become flooded or wetted (by external water). It is your responsibility, and the responsibility of any installation contractor you hire, to make sure that all applicable codes and/or local construction requirements are met. If in doubt, refer to the building authority responsible for approving the proposed installation site.

The spa must be installed in such a manner as to provide drainage away from it. Placing the spa in a depression without provisions for proper drainage could allow rain, overflow, leaks from spa plumbing, and other casual water to flood the equipment and create a wet condition in which it would sit in. For spas which will be installed below grade or recessed into a floor or deck, install so as to permit access to the equipment, either from above or below, for servicing. Make certain that there are no obstructions which would prevent removal of all side cabinet side panels and access to the jet components, especially on the side with the equipment bay.



**CAUTION:** If the spa is indoors or located in an enclosed area, proper ventilation should be discussed with an Engineer or authority competent enough to understand the necessary provisions needed to vent moist or heated air and air associated with chemical odors outdoors. **When the spa is in use considerable amounts of moisture will escape potentially causing mold and mildew.** This can cause health risk. Over time, this can damage certain surfaces, surroundings, and equipment.

## J-300

### 4.1 Outdoor Location

In selecting the ideal outdoor location for your spa, we suggest that you take into consideration:

- The proximity to changing area and shelter (especially in colder weather).
- The pathway to and from your spa (this should be free of debris so that dirt and leaves are not easily tracked into the spa).
- The closeness to trees and shrubbery (remember that leaves and birds could create extra work in keeping the spa clean).
- A sheltered environment (less wind and weather exposure can result in lowered operation and maintenance costs).
- The overall enhancement of your environment. It is preferable not to place the spa under an unguttered roof overhang since run-off water will shorten the life expectancy of the spa cover.
- For spas that are to rest on balconies, roofs or other platforms not specifically tied into main structural support, consult a professional Structural Engineer with experience in this type of application.
- In the unlikely event that you should ever need to access or gain entry to any portion of the spa for servicing, it is highly recommended that you plan your outdoor installation to provide full access to the entire spa. Please take this into consideration when placing the spa in a deck or enclosed by a surrounding.
- Consider locating your spa away from any reflective surface or glass to prevent any damage to the synthetic skirt.
- Do not shim the spa. To ensure proper support the spa must sit flat on the intended foundation.

### 4.2 Indoor Location

For indoor installations many factors need to be considered before installing a spa indoors:



**WARNING:** In addition to maintenance of filters and water chemistry, proper ventilation is recommended to reduce the risk of contracting a waterborne illness (e.g. an infection, bacteria or virus) and/or respiratory ailments that could be present in the air or water. Consult a licensed architect or building contractor to determine your specific needs if installing your hot tub indoors.

- **Proper Foundation: Consult a Structural Engineer when considering a foundation that will adequately support the spa the entire time it is in place.** Proper support is critical especially if the spa is to rest on a second story or higher. For spas that are to rest on balconies, roofs or other platforms not specifically tied into the main structural support, you should consult a professional Structural Engineer with experience in this type of application.

- **Proper Drainage: It is extremely important to have in place measures to sufficiently handle excessive water spillage.** Be sure the flooring in which the spa rests on have adequate drainage and can handle the entire contents of the spa. Be sure to make provisions for ceilings and other structures that may be below the spa's installation. Areas around your spa can become wet or moist so all flooring and subsequent furniture, walls and adjacent structures should be able to withstand or resist water and moisture.
- **Proper Ventilation: Proper ventilation should be discussed with an Engineer or authority competent enough to understand the necessary provisions needed to vent moist or heated air and air associated with chemical odors outdoors.** When the spa is in use considerable amounts of moisture will escape, potentially causing mold and mildew over time which can damage certain surfaces and/or surroundings.
- **Sufficient Access:** In the unlikely event that you should ever need to access or gain entry to any portion of the spa for servicing, it is highly recommended that you plan your indoor installation to provide full access to the entire spa.
- **Warranty:** Damage caused by not following these guidelines or any improper installation not in accordance with local codes or authorities is not covered under the spas warranty. Please consult your local state or city building ordinances.
- **Do not shim the spa.** To ensure proper support the spa must sit flat on the intended foundation.

## 5.0 General Electrical Safety Instructions

Your new Jacuzzi spa is equipped with a “state-of-the-art” equipment system. It contains the most advanced safety and self-protective equipment in the industry. Nonetheless, this spa must be installed properly to insure dependable usage. Please contact your dealer or local building department should you have any questions regarding your installation.

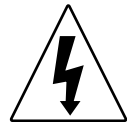

Proper grounding is extremely important. Jacuzzi spas are equipped with a current collector system. A pressure wire connector is provided on the surface of the control box, located outside the equipment door (Figure B, page 17) to permit connection of a bonding wire between this point and any ground metal equipment, metal water pipe or conduit within 5 feet (1.5m) of the spa, or copper clad grounding rod buried within 5 feet (1.5m) of the spa. Bonding wire must be at least No. 8 AWG (8.4 mm<sup>2</sup>) solid copper wire. This is a most important safety assurance feature. Before installing this spa, check with the local building department to ensure installation conforms to local building codes.

## J-300

### 120/240 Volt Convertible Models

A spa connected to a 120 VAC electrical service must be located close enough to a grounded, grounding-type electrical outlet so that the included 10 feet (3m) power cord can be plugged directly into it. **DO NOT USE AN EXTENSION CORD** as this could cause damage to the spa's equipment due to insufficient voltage. The power supplied to this spa must be a dedicated circuit with no other appliances or lights sharing the power provided by the circuit.

## 6.0 Power Requirements

Jacuzzi spas are designed to provide optimum performance and flexibility of use when connected to the maximum electrical service listed below. Minor circuit board modifications can be performed to allow your new spa to accept an electrical service other than the factory operation setting. The electrical wiring of this spa must meet the requirements of the National Electrical Code/USA (NEC) and/or any applicable state or local codes. We recommend using a Square D breaker.



**Note:** Refer to pages 66-68 for circuit board configuration details or contact your authorized Jacuzzi dealer.

### 6.1 2-Pump 240V Power Requirements

#### North American J-335, J-345, J-355, J-365, J-375 and J-385 Models (60 Hz)

	<u>240V/40A*</u>	<u>240V/50A**</u>	<u>240V/60A***</u>
Circuit Breaker (2-Pole):	40A	50A	60A
Number of Wires:	3	3	3
Frequency:	60 Hz	60 Hz	60 Hz
Current Draw:	26A	37A	48A

\* In 40A configuration, the heater **will not operate** while either jets pump is running.

\*\* In 50A configuration, the heater **will not operate** while both jets pumps are running. **This is the factory setting.**

\*\*\* In 60A configuration the heater **will operate** while both jets pumps are running.



**WARNING:** Determine the electrical requirements when working on J315 and J325 models. These models are available in a dedicated 3-wire 240V 60Hz or convertible 120V (3-wire)/240V (4-wire) 60Hz configuration.

## 6.2 Dedicated 3-Wire 240V J315/J325 Power Requirements

### J-315 and J-325 Dedicated 3-Wire 240V Models (60 Hz)

	<u>240V/40A*</u>	<u>240V/50A**</u>
Circuit Breaker:	30A, 2-Pole	40A, 2-Pole
Number of Wires:	3	3
Frequency:	60 Hz	60 Hz
Current Draw:	26A	37A

\* In 40A configuration, the heater **will not operate** while the jets pump is running.

\*\* In 50A configuration, the heater **will operate** while the jets pump is running. **This is the factory setting.**

## 6.3 Convertible 120V/240V J315/J325 Power Requirements

### North American J-315 and J-325 Convertible Models (60 Hz)

	<u>120V/15A*</u>	<u>240V/30A*</u>	<u>240V/40A**</u>
Circuit Breaker:	15A, 1-Pole	30A, 2-Pole	40A, 2-Pole
Number of Wires:	3 (15A GFCI Cord US Only*)	4 (Hard Wire Only)	4 (Hard Wire Only)
Frequency:	60 Hz	60 Hz	60 Hz
Current Draw:	12A	20A	31A

\* In 15A/30A configuration, the heater **will not operate** while the jets pump is running. **The factory setting is 120V/15A.**

\*\* In 40A configuration, the heater **will operate** while the jets pump is running.

**\*\*CAUTION: (For a 4-wire 240 VAC Heater Operation):** Make certain wires are connected exactly as shown in Figure D (page 18) before applying power. Failure to do so will result in damage to the circuit board and/or related components and void the manufacturer's warranty.

### 7.0 Electrical Wiring Instructions

**IMPORTANT NOTICE:** The electrical wiring of this spa must meet the requirements of the National Electrical Code/USA (NEC) and/or any applicable state or local codes. The electrical circuit must be installed by a qualified electrician and approved by a local building/electrical inspection authority.



1. Convertible 120/240V Power Models:

-  **DANGER: TO DECREASE THE RISK OF SHOCK, PRODUCT DAMAGE OR ELECTRICAL FIRE.**

**120V “Plug-in” Operation:** This spa must operate on the supplied 10-foot (3m) GFCI cord at its original length or must be hard-wired for longer runs. **NEVER USE AN EXTENSION CORD FOR ANY REASON!**

- Convertible 120/240V Operation: The included 120V GFCI cord must be discarded for 240V operation. This spa must be hard wired. Supplying power to either configuration above which is not in accordance with these instructions will void both the independent testing agency listing and the manufacturer’s warranty.
2. **Dedicated 240V models must be permanently connected (hard-wired) to the power supply.** No plug-in connections or extension cords are to be used in conjunction with the operation of this spa. Supplying power to the spa which is not in accordance with these instructions will void both the independent testing agency listing and the manufacturer’s warranty.
3. The power supplied to this spa must be a dedicated circuit with no other appliances or lights sharing the power provided by the circuit.
4. To determine the current, voltage and wire size required, refer to Section 6.0 “Power Requirements” (page 12).
- Wire size must be appropriate per NEC/USA and/or local codes.
  - The spa controller’s terminal block will accept a maximum wire size of 6 AWG (10 mm<sup>2</sup>).
5. The electrical supply for this product must include a suitably rated switch or circuit breaker to open all ungrounded supply conductors to comply with Article 422.20 of the National Electrical Code/USA, ANSI/NFPA 70. The disconnecting means must be readily accessible to the spa’s occupant but installed at least 5 feet (1.5m) from spa water.
6. The electrical circuit supplied for the spa must include a suitable ground fault circuit interrupter (GFCI) as required by NEC/USA Article 680.42.
7. The electrical supply for this product must include a suitably rated isolating switch and circuit breaker to comply with local electrical regulations. This RCD/GFCI circuit breaker must be installed at the power supply in the house electrical box.



8. To gain access to the equipment bay (see page 25 for accessing your hot tubs information):
  - Grab one of the corner panels, from the top, where it touches the shell. Then gently pull the panel forward to unsnap it from the holding clips, Figure 1. Tilt the panel forward and then lift to remove, Figure 2. Place the panel in a safe location to prevent from damaging it. Repeat the steps to remove the other corner panel.
  - Note:** The corner exterior lights are connected to the light wires. Take care when removing the corner panels to avoid damaging the wires.
  - Grab the bottom of the front panel and slightly lift to release it from the top mount. Tilt the panel and pull down to remove, Figure 3. Place the panel in a safe location to prevent from damaging it.
9. Select the power supply inlet you want to use (Figure A). Make sure to install a 3/4" electrical fitting and conduit through the large opening provided in the side of the control box so you can feed the cable through to the terminal block.
10. Connect wires to terminal blocks TB1 and TB3 (Figure C, page 17). **TIGHTEN SECURELY!** All wires must be hooked up securely or damage could result.
11. Install control box door and screws and reinstall the cabinet panels.

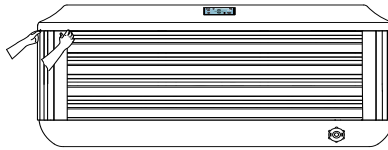

Figure 1

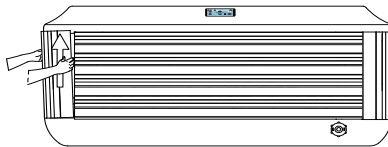

Figure 2

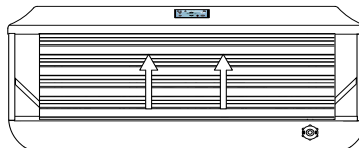
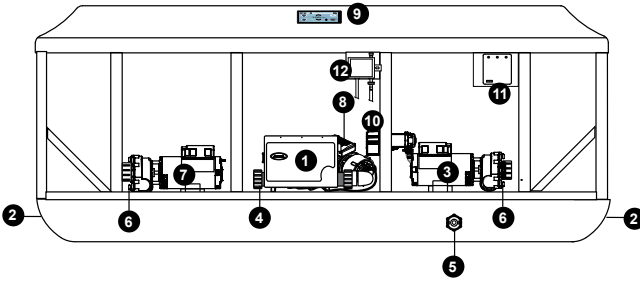

Figure 3

**Figure A  
Equipment Area  
(Standard Models)**



Note: Equipment location (such as pumps, ClearRay, drain, heater etc.) varies by model.

- |                             |                                      |
|-----------------------------|--------------------------------------|
| 1. Control Box              | 8. Circulation Pump                  |
| 2. Power Supply Entrance(s) | 9. Control Panel                     |
| 3. 1-Speed Jets Pump        | 10. ClearRay®                        |
| 4. Heater                   | 11. Optional SmartTub® System        |
| 5. Spa Drain Valve          | 12. ClearRay® PRO <sub>3</sub> TECT™ |
| 6. Pump Drain Plugs(s)      |                                      |
| 7. 1-Speed Jets Pump        |                                      |

**Equipment Area  
(Optional True™ Water Care System Models)**

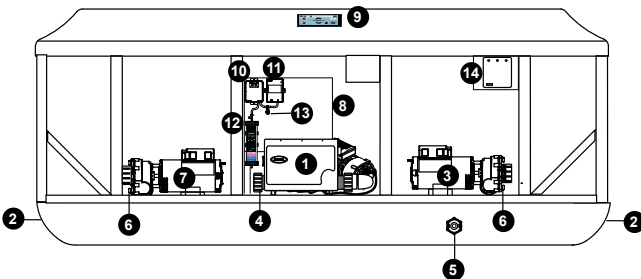

- |                             |                               |
|-----------------------------|-------------------------------|
| 1. Control Box              | 8. Circulation Pump           |
| 2. Power Supply Entrance(s) | 9. Control Panel              |
| 3. 1-Speed Jets Pump        | 10. Air Pump                  |
| 4. Heater                   | 11. Ozone                     |
| 5. Spa Drain Valve          | 12. Air Filter                |
| 6. Pump Drain Plugs(s)      | 13. Pressure Sensor           |
| 7. 1-Speed Jets Pump        | 14. Optional SmartTub® System |



**Figure D**  
**(North American 60 Hz J315 and J325 120/240 VAC**  
**Convertible Models)**

**CAUTION: THIS SECTION IS NOT APPLICABLE TO THE J315 AND J325 DEDICATED 3-WIRE 240V 60HZ MODELS.**

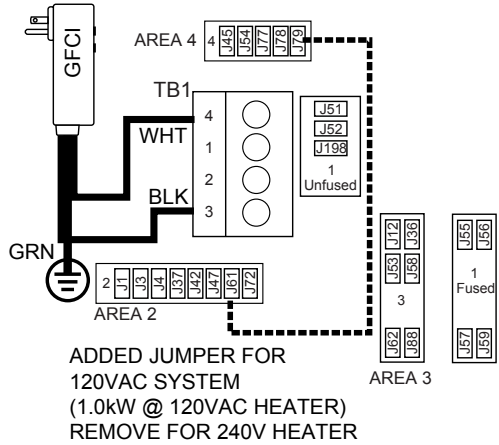
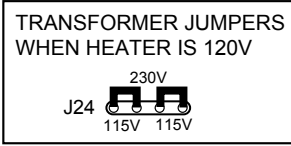
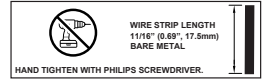

**FOR 240V HEATER:**

REMOVE JUMPER BETWEEN AREA 2 AND AREA 4 BEFORE REMOVING GFCI CORD AND CONNECTING A 30A 240VAC GFCI-PROTECTED SERVICE. THERE SHOULD BE NO WIRES GOING TO AREA 2 WHEN HEATER IS 240V.

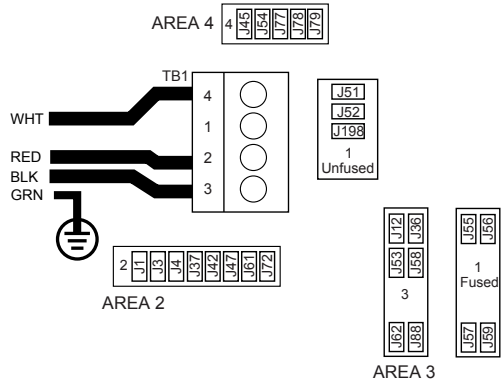
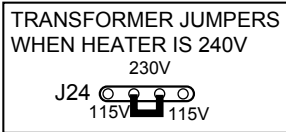

**NOTE:** 120V SERVICE IS LIMITED TO 12A (15A BREAKER) WHEN USING GFCI CORD. FOR 16A SERVICE (20A BREAKER), A WALL-MOUNTED GFCI MUST BE USED.

## 8.0 Spa Fill Up Procedure

For best results, read each step in its entirety before proceeding with that step. **Make sure all drains are closed before you begin, page 16.**

### 1. Prepare The Spa for Filling

- Clear all debris from the spa. Although the spa shell has been polished at the factory, you may want to treat it with a specially formulated spa cleaner. Consult your authorized Jacuzzi dealer for additional information prior to filling spa.
- If using the primary filter fitting to fill, remove filter cover, then remove filter cartridge as outlined in Section 12.1 (page 49).

**IMPORTANT:** In most cases, filling the spa by placing the hose in the footwell will not create an airlock, page 64. If you experience an airlock, we recommend filling by placing the end of your garden hose into the primary filter fitting inlet. This wall fitting is the one closest to the front of the spa, page 49.

### 2. Fill Spa

- Place the end of your garden hose into the empty primary filter fitting or into the footwell. Fill until water covers all jets but does not touch the bottom of the lowest headrest. (DO NOT OVERFILL!)
-  **WARNING: TO DECREASE RISK OF INFECTION OR DISEASE.**  
Fill hot tub with clean tap water from garden hose to reduce risk of contracting a waterborne illness (e.g. an infection, bacteria or virus) and/or respiratory ailments. Fill until water covers all jets but does not touch the bottom of the lowest headrest. (DO NOT OVERFILL!)



**CAUTION: TO DECREASE BUILD UP ON COMPONENTS AND MINIMIZE ACRYLIC DAMAGE.** Never fill with water from a water softener. If your water is extremely “hard,” it is preferable to fill half-way with hard water and the rest of the way with softened water. Water that is too soft can be corrosive to metal components.

### 3. Turn on Power (Priming Mode)

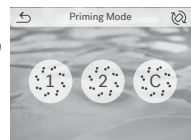
- Turn on power to spa at the home’s circuit breaker to start the priming of the pumps.
- After power is applied, the control panel displays a sequence of configuration settings.
- Then it will display the Priming Mode Menu.
- To begin the Priming Mode, press the Jets 1 button. If you have a two-pump system, press the Jets 2 button to turn the pump on. Then press the circulation pump button to activate. This cycle will last about 3-5 minutes.



## J-300

- After the cycle ends, the display briefly shows the set temperature. Then it displays “- - - - °F” until the actual water temperature is determined. You can manually turn the pumps off after the temperature is displayed.  

**Note:** You can skip the Priming Mode by pressing the Back button (  ). This is not recommended.

### 4. Activate Jets Pumps

Turn on jets pump(s) to ensure proper mixing when adding start-up chemicals in step 5. 

### 5. Add Start-Up Chemicals

Add the spa water chemicals as recommended by your authorized Jacuzzi dealer. See “Water Quality Maintenance” (page 56) for general guidance.



#### **WARNING: RISK OF POISONING OR DEATH.**





Never leave chemicals opened and accessible to anyone. Use chemicals according to the vendors instructions. Always store chemicals in a safe and/or locked location. Keep away from and out of reach of children.

### 6. Establish A Stable Sanitizer Reading

Establish a stable sanitizer reading of no less than 1.0 ppm free chlorine or 2.0 ppm bromine. To ensure healthy water conditions, always maintain a constant sanitizer reading within the levels recommended on the inside cover of this manual.

### 7. Set Spa to Heat

To warm spa water to a comfortable temperature, follow these steps:  

- The LCD display on the control panel displays the actual temperature of the spa water. Press either the COOLER (  ) or WARMER (  ) button once to display the “set” temperature for 5 seconds. If you want the water to heat to a different temperature, simply press COOLER (  ) or WARMER (  ) within 5 seconds. The set temperature increases or decreases by 1°F (0.5°C) each time one of these buttons is pressed.
- The heater will turn off when the temperature corresponding to the thermostat setting is achieved.

**Important Heater Details:**

- The maximum water temperature setting for your spa is 104°F (40°C) and the minimum setting is 65°F (18°C).
- For North American spas connected to a 40-amp service, jets pump #1 and jets pump #2 must be turned off to operate the heater.
- Setting the thermostat at maximum will not accelerate the heating process. This will only result in a higher ultimate temperature.
- The heater operates until the water reaches the programmed “set temperature,” then turns off. The heater will reactivate after the water cools to approximately 2°F (1°C) below the set temperature.

**8. Place Cover on Spa**

- Keeping the insulating cover in place anytime the spa is not in use will reduce the time required for heating, thereby minimizing operating costs.
- The time required for initial heat-up will vary depending on the starting water temperature.

**DANGER: RISK OF PERSONAL INJURY.**

Check water temperature carefully before entering hot tub! Excessive water temperature can cause burns, welts and body temperature to rise, hyperthermia (over-heating).

**Decontamination Procedure (Steps 9-15)**

Steps 9-15 below are only required when sanitizer levels are unstable after performing steps 1-6 above. Disregard steps 9-15 below if sanitizer levels remain stable after performing steps 1-6 above (refer to the inside cover of the manual).

**Note:** The “decontamination procedure” steps 9-15 should also be used after the spa has been “Winterized” (page 54) or has been sitting without power for an extended period.

9. Add 2.5 ounces (71 g) of sodium dichlor for every 100 gallons (378 Liters) of water. Refer to the table below for approximate water fill volume by model.

**CAUTION: RISK OF PERSONAL INJURY OR SPA DAMAGE!**

Never add chlorine tablets (trichlor) or acid to your hot tub for any reason! These chemicals may damage components within your hot tub, burn or irritate your skin, create a rash, and void the manufacturer warranty for your spa.

## J-300

### Water Fill Volume by Model

Spa Model	Average Fill Volume*	Sodium Dichlor
J-385	500 Gal (1,893 L)	12.5 oz
J-375	470 Gal (1,779 L)	11.75 oz
J-365	440 Gal (1,666 L)	11.0 oz
J-355	400 Gal (1,514 L)	10.0 oz
J-345	370 Gal (1,401 L)	9.25 oz
J-335	360 Gal (1,363 L)	9.0 oz
J-325	360 Gal (1,363 L)	9.0 oz
J-315	230 Gal (871 L)	5.75 oz

\*Use average fill volume for chemical maintenance

10. Leave spa cover open during this step to allow excessive chemical vapors to exit spa, protecting pillows and plastic knobs from chemical attack. If spa is indoors, open doors and windows for proper ventilation. Turn on all jet pumps for one hour, then place the massage selector knob in the center “combo” position and open all air controls.



**Note:** You will need to press the jets pump button(s) every 20 minutes since these functions have an automatic 20-minute time-out function that turns them off.



#### **WARNING: RISK OF PERSONAL INJURY!**

- To decrease the risk of injury, drowning or entrapment, never leave your hot tub unattended for any reason while the cover is open and accessible, especially to small children and animals!
- Precautions should be taken to minimize your exposure to chemical vapors (that could cause lung, brain, or skin damage).

11. Turn off power to the spa at the circuit breaker, then drain spa as outlined in “Draining and Refilling” (page 51).
12. Fill spa until water covers all jets but does not touch the bottom of the lowest headrest. **DO NOT OVERFILL.**



**CAUTION: TO DECREASE BUILD UP ON COMPONENTS AND MINIMIZE ACRYLIC DAMAGE.**

Never fill with water from a water softener. If your water is extremely “hard,” it is preferable to fill half-way with hard water and the rest of the way with softened water. Water that is too soft can be corrosive to metal components.

13. Consult your authorized Jacuzzi dealer for chemical recommendations, then add chemicals to hot tub water to achieve a constant sanitizer reading within the levels recommended on the inside cover of this manual.
14. Turn on all jets pump(s) when adding chemicals to ensure proper mixing and leave your hot tub cover open until the sanitizer level becomes stable to protect pillows and plastic knobs from chemical attack. Refer to the inside cover of the manual.



**WARNING: RISK OF PERSONAL INJURY.**

- To decrease the risk of injury, entrapment or drowning, never leave your hot tub unattended for any reason, especially if while the cover is open and accessible to small children and animals!
- To decrease the risk of contracting a waterborne illness (e.g. an infection, bacteria or virus) and/or respiratory ailments, maintain water chemistry within 6 step parameters. If you or other bathers experience such a condition, discontinue use and seek immediate medical attention.

15. Establish a sanitizer reading no less than 1.0 ppm free chlorine or 2.0 ppm bromine, then allow the hot tub to set undisturbed for 8 hours. Retest water after 8 hours to determine if sanitizer levels are stable. If sanitizer levels are stable, your spa is ready for use. To ensure healthy water conditions, always maintain a constant sanitizer reading within the levels recommended on the inside cover of this manual. If sanitizer levels are not stable at this time, it will be necessary to repeat this procedure in its entirety (steps 1-15) until stable sanitizer readings are achieved.

**IMPORTANT:** If the ClearRay Active Oxygen® system is removed from the hot tub or is not operating effectively follow the “without ClearRay” water chemistry parameters as defined by the Pool & Hot Tub Alliance.

16. After adequate sanitizer levels are achieved, close all spa air controls to maximize heat retention when spa is not in use.

9.0 General Spa Features and Controls

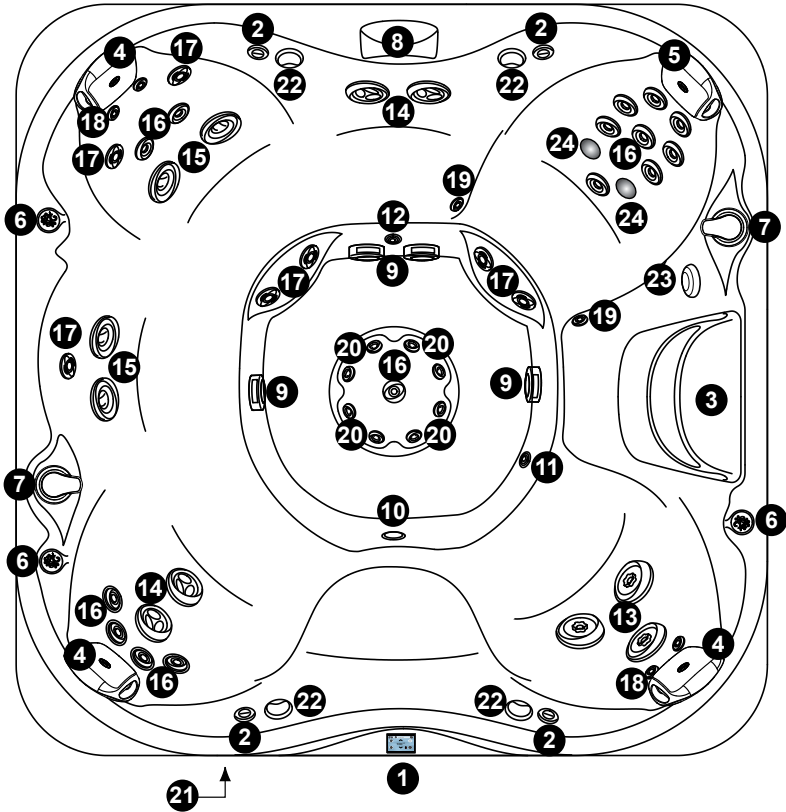

J-385 model illustrated - Location of features varies by model. Specifications/features subject to change without notice.

- |  |  |
|--|--|
| 1. Control Panel                                   | 13. PowerPro® MX2 Jets                   |
| 2. Toggle Air Controls                             | 14. PowerPro® FX Large Rotational Jets   |
| 3. Filter/Skimmer Grill                            | 15. PowerPro® FX Large Jets              |
| 4. Standard Pillows                                | 16. PowerPro® FX Jets                    |
| 5. HydroSoothe™ Pillow                             | 17. PowerPro® FX Rotational Jets         |
| 6. Lighted Cup Holders*                            | 18. PowerPro® NX2 Jets                   |
| *Light features not offered on J-315/J-325 Models. |  |
| 7. Massage Selector Valves                         | 19. PowerPro® BX Jets                    |
| 8. Waterfall Feature                               | 20. PowerPro® Mini FX Jets               |
| 9. Footwell Suction Fittings                       | 21. Optional BLUEWAVE® Spa Stereo System |
| 10. Spa Light                                      | 22. Optional Stereo System Speakers      |
| 11. Heater Return Fitting                          | 23. HydroSoothe™ Pillow Valve            |
| 12. Waterfall overflow                             |  |

Specifications Subject to Change Without Notice.

## 10.0 Operating Instructions

When power is first applied, the control panel screens below will be displayed, Figure A. Then you will need to active the Priming Cycle, page 19.

**Note:** The start-up sequence will time out after approximately 20 seconds.



Figure A

## 10.1 Register Your New Spa

Registering your spa is important in order to validate your warranty. To register you will need to have the spa serial number, Figure B. The best time to retrieve the serial number is when the spa is being connected. You must register your spa via the internet at [www.Jacuzzi.com](http://www.Jacuzzi.com).

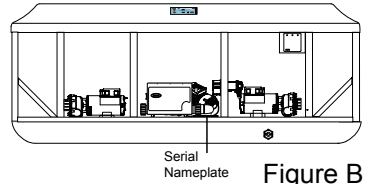

Figure B

Follow these steps to register your spa.

1. Using your home computer or other device, connect to the internet.
2. Go to [www.Jacuzzi.com](http://www.Jacuzzi.com) website to register your spa.
3. Click **Outdoor Hot Tubs**
4. Click **For Owners**
5. Click **Warranty and Manuals**
6. Click **Warranty Registration**
7. Enter your serial number.

Keep a record of your serial number for any future reference. Write that information below.

Serial Number: \_ \_ \_ \_ \_

## J-300

### 10.2 Control Panel

Your Jacuzzi Spa is equipped with a state-of-the-art touch screen control panel. The control panel complements the contemporary and sleek design of your spa. Access to all menus can be achieved by using the touch screen. Programming features can be easily programmed with our user-friendly design. With the ease of use, there will more time to enjoy the benefits of your spa.



Figure A

#### A. Home Menu Control Buttons

The Home Menu provides access to spa functions and programming. Operation is made easy by the interactive touch-screen control panel. If there is no activity for 1 to 5 minutes (page 43), the LCD display will time-out into a sleep mode. To reactivate the display, just tap the display. Then tap the buttons displayed.

**Note:** When a feature is on, the button will have a darker appearance.



**Temperature Control:** Allows you to adjust the set temperature of the spa:

- Increase the temperature by tapping in 1°F (0.5°C) increments.
- Decrease the temperature by tapping in 1°F (0.5°C) increments.

**Note:** The temperature range for the spa is 65 to 104°F (18.33 to 40°C). To activate the Extended Temperature feature that allows the spa to reach 106°F (41°C), see page 63.



Fahrenheit Icon is flashing means the temperature is being adjusted



Flashing thermometer indicates the system is checking for proper water flow before heater is activated.



Solid thermometer icon displayed on Home menu indicates spa is heating



















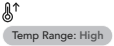

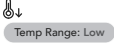
Flashing temperature up icon indicates the spa is in the extended temperature feature.

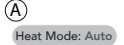

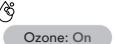
**Jet Button:** Tap to access the menu to operate the jets pump, page 28.

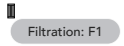

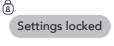
**Light Button:** Tap to access the menu to operate the various lighting options, page 29.

- 
 = **ClearRay Button:** Tap to activate the ClearRay Active Oxygen® system on demand feature (UV and Ozone), page 31.
- 
 = **Boost Cycle Button (with optional True Water Care System):** Tap to activate the Cleaning Boost feature. Activates the True™ Water Care for 60 minutes (Circ, Air Pump, and Ozone). Can turn off by pressing button again.
- 
 = **Settings Button:** Tap to access the programming and setting menus, page 34.
- 
 = **Invert Button:** Tap to invert the display image.
- 
 = **Error/Reminder Indicator Icon:** Displays when there is error or reminder message that needs to be addressed.
- 
 = **Temperature High Range icon:** Indicates that the spa is set to high range temperature between 80°F (26.5°C) and 104°F (40°C). Tap the icon to display the information. 
- 
 = **Temperature Low Range icon:** Indicates that the spa is set to low range temperature between 65°F (18.5°C) and 99°F (37°C). 
- 
 = **Heat Mode Icon:** Indicates the heat mode that is activated. Tap to display information. 
- 
 = **Ozone Icon:** Indicates that the Ozone is on. Tap to display information. 
- 
 = **Filtration icon:** Indicates that a filtration cycle is on. Tap to display information. 
- 
 = **CleanUp Cycle icon:** Will display when the CleanUp Cycle is on.
- 
 = **Lock Icon:** Displays when one of the lock modes is enabled, page 41. Tap to display information. 
- 
 = **Wi-Fi Icon:** Will display if the optional SmartTub® system is installed.

12:00 PM = **Time Indicator:** The time will always be shown when the Home Menu is displayed. The appearance will vary depending on whether the clock is set to a 12-Hour or 24-Hour configuration, To Program the time see page 38. The default setting is 12-Hour.

**Note:** The time does NOT automatically adjust for daylight saving time. The time must be manually adjusted.

## J-300

### 10.3 Activate Jet Pumps

From the Home Menu, (Figure A), tap  to enter the Submenu. The panel will display the Jets Pump Submenu (Figure B).

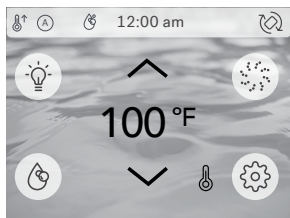

Figure A

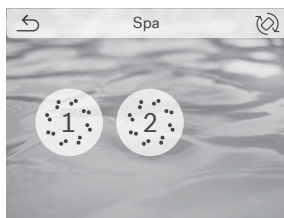

Figure B



= **Jets Pump 1 Button**



= **Jets Pump 2 Button (If equipped)**



= **IR Therapy Light Button (If equipped)**



= **Back Button:** Tap to go back to the Home Menu.

#### A. Jets Pumps

1. Tap the Jets 1 button to turn the pump on and off.
2. Tap the Jets 2 button to turn the pump on and off.

**Note:** Anytime a pump has been manually turned on, it will automatically turn off after approximately 20 minutes. If at this time you desire more jet operation you may simply turn the pump(s) back on.

#### B. IR therapy Lights (if equipped)

1. Tap the IR therapy light button to turn on and off.
2. Tap “OK” on the pop-up menu to activate for a 20-minute period, Figure C. The display will change to Figure D.

**Note:** If the system is not equipped with the IR therapy lights the IR icon will not be displayed.

Figure E displays the Home menu when the IR therapy lights, if equipped, are on.

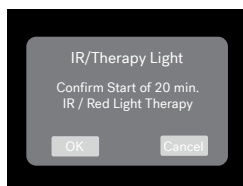

Figure C

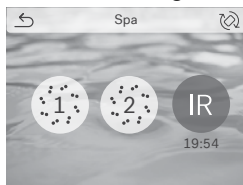

Figure D

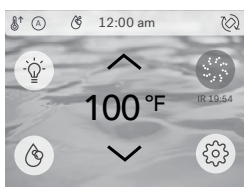



Figure E



### 10.4 Activating the Lights

From the Home Menu, (Figure A), tap  to enter the Light Submenu. The LCD screen will display the Light Submenu (Figure B). From this menu you can control the hot tub lighting.

**Note:** The interior lights automatically turn off after 2 hours. They can be reactivated if needed.

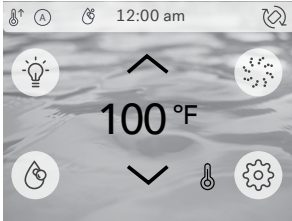

Figure A

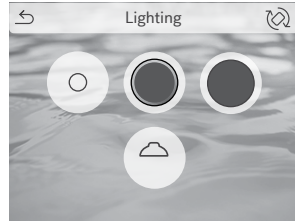

Figure B



= **Interior/Intensity Light:** Press to activate the interior lights. The lights will default to the last setting used at a 100% intensity. The lights can also be turned on by selecting a color or pressing the blend button.



High Intensity



Med Intensity



Low Intensity



= **Speed Control:** Controls the blending speed for the lights.  
 • Tap  to increase or freeze the blending speed, of the colors.



Low



Med



High



Freeze



= **Solid Color Selector:** Continually tap to scroll through and select a single color. The colors available are red, orange, green, teal, blue, violet, white, and yellow.



= **Exterior Light:** The exterior corner lighting has 2 settings. The lights display a solid White color only. By continually tapping the button you will scroll through the following:

- Press once for high intensity. Press a second time for Auto feature. Press a third time to turn off.
- High Intensity
- White color
- 8-hour timeout
- High Intensity
- White color
- Lights on from 7pm to 12am



= **Back Button:** Tap to go back to the Home Menu.

## J-300

### 10.5 Jets

The water flow through individual jets in your spa can be adjusted or turned off by rotating the outside jet ring. Some jets offer an adjustable center nozzle that allows you to change the water discharge angle. Simply tilt the center nozzle in these jets to the desired angle to customize your personal massage. Other jets offer a spiral action that produces a surging stream of air and water that provides a vigorous massage.



**Note:** Always keep at least 6 adjustable jets open at all times to ensure proper filtration characteristics within the spa.

### 10.6 Selecting Desired Massage Action

All models incorporate a massage selector valve that allows you to customize the massage and performance by diverting water between various jet systems within the spa. Simply turn valve to positions A, B or C to divert water pressure to various jet groups.



**Note:** The valve is intended to operate in positions A (Combo), B, or C for optimum performance. It is considered normal for sound levels within the valve to increase between these positions due to the large amounts of water flowing through it. For optimum filtration benefits, always leave this valve in position A when the spa is covered and select positions B or C for maximum jet performance during spa use.

### 10.7 HydroSoothe™ Valve Control

Turn control valve (page 24) from side to side to increase output, decrease output or turn off the HydroSoothe jets.





**Note:** When the valve is in the OFF position, some water may still flow through. This is considered normal.

### 10.8 Waterfall Feature

The waterfall feature allows you to independently control it for a customized soothing effect.



#### For J335-J385

The waterfall is on when the circulation pump is on. The JETS 1 (  ) or ClearRay (  ) buttons will also activate the waterfall feature.

#### For J315 and J325

The waterfall is on when the jets pump 1 is on.

Waterfall Operation Details:

- A. Push thumb wheel on top of waterfall to the left (while in spa) to start or increase flow.
- B. Push thumb wheel on top of waterfall to the right (while in spa) to slow or turn flow off.

**Note:** When the waterfall is in the OFF position, some water may still flow through. This is considered normal.





### 10.9 ClearRay on Demand (Standard Models)

The ClearRay Active Oxygen® system on demand feature activates the water purification system. Continuously tap  to activate the system for 1 hour, 2 hours, 3 hours or OFF. During this time the circulation pump and the ClearRay Active Oxygen® system (UV and Ozone) are on.

**Note:** When the ClearRay Active Oxygen® system is on, due to a programmed or scheduled setting, the feature cannot be turned off.

### 10.10 Air Controls

Certain jet systems have their own “toggle” on/off air control. Each control introduces air into the water lines that supply specific jet groups. Simply press any air control button to open or press the opposite side of button to close.



**Note:** To minimize heat loss, close all air controls when spa is not in use. Certain jets may draw air even though they are closed. This is considered normal.

### 10.11 Optional BLUEWAVE® Spa Stereo System

Spas equipped with the optional audio system offer enhanced spa experience. These models include a high-quality Bluetooth® stereo receiver with four high-quality marine speakers for unsurpassed sound quality and long-life. An auxiliary device can be connected, via a 3.5 mm plug cable, located behind the front cabinet panel, if a Bluetooth device is not available.

### 10.12 Cleanup Cycle

The cleanup cycle occurs once per day at 12:00 PM (noon) for 2 minutes. This is not user programmable. The Jets Pump 1 and the Circulation Pump will turn on for one minute and then shut off. Then Jets Pump 2 will turn on and run for 1 minute then shut off.

**Note:** Turning off the corresponding jets pump that is running can deactivate the cycle.

### 10.13 Optional SmartTub® System

Advances in technology have allowed us to create a better and smarter hot tub. Our SmartTub® system operates on a cellular network. The advantages of this system are:

- A more stable connection to internet for outdoor environment. The SmartTub® device uses much less data than a typical voice connection via cellular networks. We contract through the largest wireless carriers to ensure maximum uptime. The system enables firmware updates via the cell connection so your system's performance will continuously be optimized remotely.
- Maintenance is made easy by alerts sent to your phone.
- Diagnostic alerts are sent to you and your dealer when attention is required.

## J-300

### A. Pairing process

1. Download the SmartTub® app from the Google Play store or Apple App store.
2. Open the app and create an account.
3. Locate the SmartTub® sticker next the control panel of the hot tub. You can either scan the QR code with the SmartTub® app or manually input the serial number located below the QR code on the sticker.
4. After you pair the hot tub's serial number to the SmartTub® app, the app will load and connect the hot tub to the internet.
5. Follow the instructions on the app to begin enjoying the benefits of your internet connected hot tub.

**Note:** The first year of data service is included. You will need to renew the subscription after the first year. Please refer to the terms of service and privacy policy links in the SmartTub® app for additional information.

### B. Indicator Lights

There are indicator lights on the SmartTub® controller that relay the status of the system. Below are meanings of the lights.

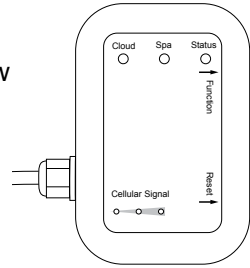

1. Cloud:
  - Blue light on - connected to cloud.
  - Blue light off - not connected to cloud.
2. Spa:
  - Blue light on - connected to spa controller
  - Blue light off - not connected to spa controller
3. Status:
  - Cyan light - breathing (slow pulsing) indicates the status is good.
  - Cyan light - flashing indicates that the system is completing a connection to the cloud.
  - Green light - flashing indicates waiting for a connection to the cellular tower.
  - Dark blue light - flashing indicates a SIM error.
4. Cell signal strength:
  - 3 blue LED lights indicate cell signal strength.

### C. Resetting the SmartTub® controller

Should the SmartTub® controller need to be reset, hold a magnet to the reset label on the side of the SmartTub device.

## 10.14 Exterior Lights

The exterior lights are located on the corners of the cabinet panels. They provide a soft light luminance around the spa. The only light color option is white. The lights have a time-out period of 8 hours. The lights can be controlled through the Light button or via the Menu button. For operating instructions refer to page 29.



### **10.15 IR and Red Light Therapy**

Exclusive patented Infrared technology only in a Jacuzzi® hot tub. Located in the lower back of the FX Therapy seat to aid in the relief of muscle pain. Infrared uses specific wavelengths of light to penetrate below skin to deep tissue.

**Note:** The IR and Red light device used in this spa has been tested both in a dry and submerged state by certified Intertek® test laboratories. Testing was conducted for this device to the IEC 62471 – Photobiological Safety Standard. Results place this device in the Risk Group 0 (RG0) exempt category.

## J-300

### 11.0 Menu Features and Programming Instructions

Your spa is equipped with menus that allow you to program and activate different components of the spa. With our control panel, programming your spa has never been easier. From the Home Menu, tap  to enter the Settings Menu, Figures A and B. Scroll up and down through the Settings Menu to see all options.

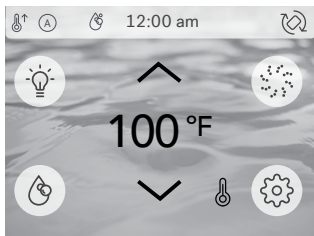

Figure A

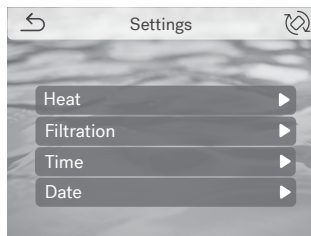

Figure B

**Heat:** Provides access to the heating programming, page 35.

**Filtration:** Provides access to the filtration programming, page 36.

**Time:** Provides access to the time programming, page 38.

**Date:** Provides access to the date programming, page 38.

**Water Care:** Provides access to the water care programming, page 39.

**Lock:** Provides access to activate the locking features, page 41.

**Units:** Provides access to the temperature and time display feature, page 42.

**Language:** Provides access to the language selection, page 42.

**Panel:** Provides access to the sleep and wake programming of the control panel, page 43.

**Diagnostic:** Provides access to the hot tub information, page 43.



= **Back Button:** Tap to go back to the previous Menu.

---

### Models Equipped with the True™ Water Care Purification System:

**True™:** Provides access to the True™ Water Care programming, page 46.

### 11.1 Programming the Heat Settings

Your spa is equipped with 3 modes of heating. An automatic mode called “Auto” where the spa’s temperature is always maintained. An energy saving heating cycle called “Economy.” A mode that will only activate the heater during the daytime called “Day” mode.

**Note:** The heater will activate when the temperature drops 2°F (1°C) from the set temperature.

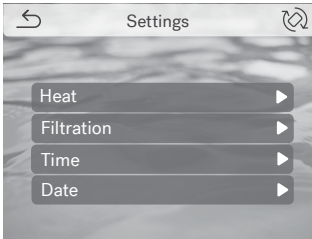

Figure A

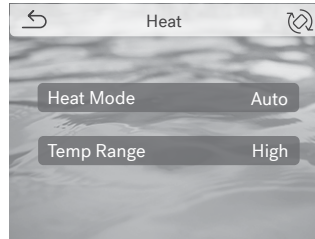
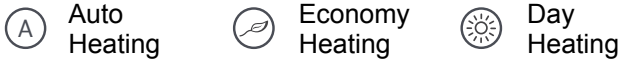

Figure B

#### **Heat Mode:**

From the Settings Menu, tap **Heat** to enter the Heat Settings submenu, Figure A. Tap **Heat Mode Auto** to enter the menu, Figure B. Then scroll to select one of the heating settings, Figure C.



#### **A. Auto heating:**

1. When programmed to Auto, the spa will maintain the water temperature to the set temperature. Heating will occur when necessary.
2. To select this mode, highlight the Auto tab and press the set button (⊙).

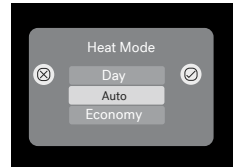

Figure C

#### **B. Economy heating:**

1. This is an energy saving heating program that allows the spa to heat during non-peak hours. When programmed to Economy, the spa will only be allowed to heat the water between 5:00 PM to 7:00 AM every day. The hours cannot be adjusted.
2. To select this mode, highlight the Economy tab and press the set button (⊙).

#### **C. Day heating:**

1. When programmed to Day, the spa will only be allowed to heat the water between 7:00 AM to 5:00 PM every day. The hours cannot be adjusted.
2. To select this mode, highlight the Day tab and press the set button (⊙).

# J-300

## 11.2 Programming the Primary Filtration

To access the Filtration settings, tap **Filter** from the Settings menu, Figure A, to enter the Filtration programming, Figure B.

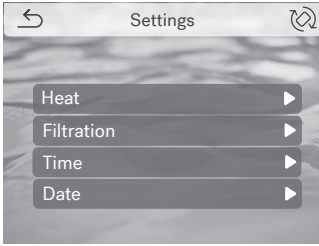

Figure A

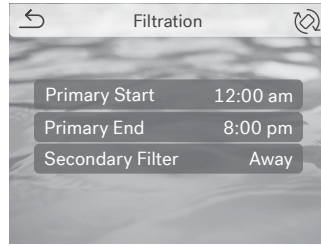

Figure B

During a primary filtration, the circulation pump and the ClearRay Active Oxygen® system are activated. The factory default cycle starts at 12:00 AM and last for 8 hours. If you elect to keep this setting, then you can skip this section.



In extreme bitter cold weather, where freezing can occur, we recommend you program the primary filtration cycle to run 24 hours. Refer to the “Winterizing” section on page 54.

### A. To change the default cycle:

Tap **Primary Start 12:00 am** to enter the menu, Figure C.

**Note:** If **(X)** is pressed, in the middle of programming, it will clear the changes made and return to the prior programmed settings.

1. Scroll through the first column to change the hour in 1-hour increments. You cannot adjust the minutes column.
2. To select AM or PM, you will need to round a 12-hour period.
3. Tap **(OK)** to accept and save the change.
4. Tap **Primary End 8:00 pm** to program the end time for the cycle, Figure D.
5. Scroll through the first column to change the hour in 1-hour increments. You cannot adjust the minutes column.
6. To select AM or PM, you will need to round a 12-hour period.
7. Tap **(OK)** to accept and save the change.
8. Tap **(Back)** twice to return to the Main Menu.

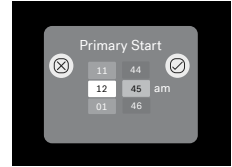

Figure C

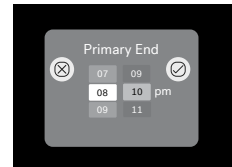

Figure D

Any time the circulation pump runs outside of a program cycle, e.g. for heating, that run time will be deducted from the next primary filter cycle. For example, the primary filter cycle is set to 8 hours every 24 hours, but the circulation pump comes on for 2 hours to heat the water after the cycle has finished. The next primary filter cycle will only be for 6 hours not 8 hours.

### 11.3 Programming the Secondary Filtration

The jets pump 1 activates during the secondary filtration, Figure A, to provide additional skimming. The spa is programmed with a default setting of Away Mode but can be programmed to other modes. There are 3 different modes, Away, Infrequent, and Frequent, Figure B.

**Note:** During the secondary filtration the jets pump 1, circulation pump and ClearRay Active Oxygen® system are activated.

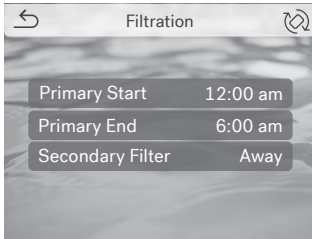

Figure A

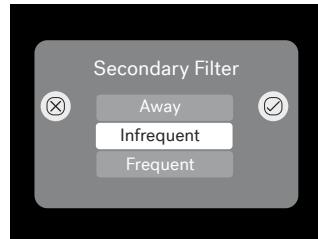





Figure B

- Away Mode disables the Secondary Filtration.
- Infrequent Mode will activate two 10-minute cycles **every other day**; one at 8:00 AM and the other at 8:00 PM.
- Frequent Mode will activate two 10-minute cycles **every day**; one at 8:00 AM and the other at 8:00 PM.

#### A. Secondary Filtration Cycle Menu

To change the programmed Secondary Filtration Cycle:

1. Press **Secondary Filter** **Away** to enter the Options Menu, Figure B.
2. Scroll through the 3 different modes Away, Infrequent, and Frequent.
3. Once a selection is made, press  to confirm and activate the setting. The system will return to the previous menu.
4. Tap  twice to return to the Main Menu.

**Note:** If  is pressed it will clear the changes made and return to the prior programmed settings.

## J-300

### 11.4 Programming the Time

From the Settings Menu, tap **Time** to enter the programming options, Figures A and B.

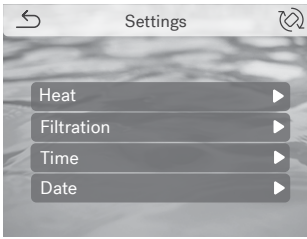

Figure A

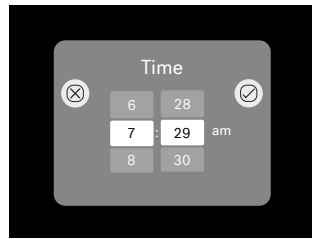

Figure B

#### A. To set the time (Figure B):

The default time setting is a 12-hour configuration. To choose the 24-hour configuration see page 42.

1. Scroll through the first column to change the hour in 1-hour increments.
2. Scroll through the second column to adjust the minutes.
3. To select AM or PM, you will need to round a 12-hour period.
4. Tap to accept and save the change.
5. Tap to return to the Main Menu.

### 11.5 Programming the Date

From the Settings Menu, tap **Date** to enter the programming options, Figures A and B.

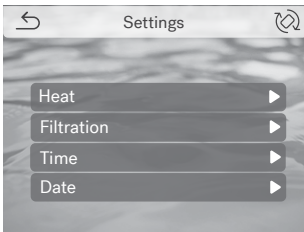

Figure A

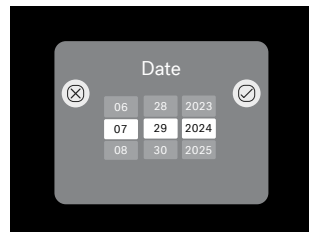

Figure B

#### A. To set the date (Figure B):

1. Scroll through the first column to set the month.
2. Scroll through the second column to set the day.
3. Scroll through the third column to set the year.
4. Tap to accept and save the change.
5. Tap to return to the Main Menu.



## 11.6 Water Care Programming

Water care is crucial to maintaining a clean spa. The ClearRay Active Oxygen® system leads the way to a clean\* spa by using a UV light bulb and ozone. Your spa can be programmed to remind you when to check and replace certain components.

From the Settings Menu, tap **Water Care** to enter the Water Care Menu, Figures A and B. Then select one of the features.

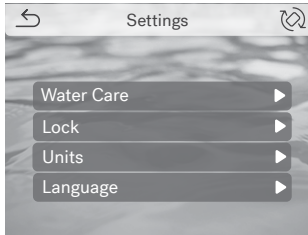

Figure A

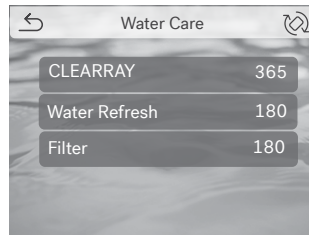

Figure B

### A. Programming the ClearRay UV Bulb Timer

The ClearRay UV bulb has a life expectancy of 1 year. A timer activates when power is applied and begins a countdown starting at 365 days. Once the timer expires, a reminder message will appear on the display, the UV bulb must be replaced, and the timer needs to be reset. Tap **CLEARRAY 365** to enter the Programming Menu.

#### Note:

- The days are stored in memory if the power is interrupted.
- The ClearRay UV timer counts down by days not usage.

1. From the Water Care Menu, you can set the ClearRay UV bulb timer, Figure C.
2. Scroll through the column to change the days in 10-day increments. The range is from OFF (- - -) to 365 days. It is not recommended that this feature be turned OFF. To continually have the ClearRay system effectively perform its function, it should be program as instructed.



**Note:** Pressing **(X)** will clear current changes made. The days will return to the previous programmed setting. This feature can be used to make corrections.

3. Tap **(✓)** to accept and save the change. The display will return to the Water Care Menu.
4. Tap **(←)** twice to return to the Main Menu.
5. When the timer expires, a message will appear on the control panel display. The ClearRay UV bulb **must be replaced** (page 62) and the timer must be reset. Tap **(✓)** and follow the instructions above to reset the timer. If you tap **(⌚)** the message will clear but the reminder icon **(!)** will display and the message will reappear in 10 days.

\*Clean is defined as the removal of microscopic (to 30 µm level) debris from the water. Ozone aids in the grouping of small debris. Once combined, the debris can be more easily caught by the filtration process.

## J-300

### B. Programming the Water Refresh Timer

A programmable Water Refresh reminder can be set to remind you when to drain and refill the spa. Tap **Water Refresh** 180 (Figure B) to enter the Programming Menu.

1. From the Water Care Menu, you can set the Water Refresh timer, Figure D.
2. Scroll through the column to change the days in 30-day increments. The range is from OFF (- - -) to 180 days. It is not recommended that this feature be turned OFF. To continually maintain the water healthy and clean, in addition to chemical maintenance, it should be program as instructed.

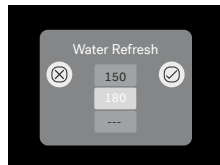

Figure D

**Note:** Pressing (⊗) will clear current changes made. The days will return to the previous programmed setting. This feature can be used to make corrections.

3. Tap (✓) to accept and save the change. The display will return to the Water Care Menu.
4. Tap (↶) twice to return to the Main Menu.
5. When the timer expires, a message will appear on the control panel display. The water must be drained and replaced with fresh water. Tap (↷) and follow the instructions above to reset the timer. If you tap (Ⓜ) the message will clear but the reminder icon (⚠) will display and the message will reappear in 10 days.

### C. Programming the Filter Timer

A programmable filter timer can be set to remind you when to clean or replace the filters. Tap **Filter** (Figure B) to enter the Programming Menu.

1. From the Water Care Menu, you can set the Filter timer, Figure E.
2. Scroll through the column to change the days in 10-day increments. The range is from OFF (- - -) to 180 days. It is not recommended that this feature be turned OFF. To continually maintain clean and working filters, it should be program as instructed.

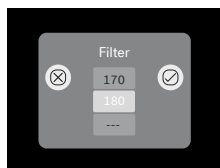



Figure E

**Note:** Pressing (⊗) will clear current changes made. The days will return to the previous programmed setting. This feature can be used to make corrections.

3. Tap (✓) to accept and save the change. The display will return to the Water Care Menu.
4. Tap (↶) twice to return to the Main Menu.
5. When the timer expires, a message will appear on the control panel display. The filter must be cleaned or replaced. Tap (↷) and follow the instructions above to reset the timer. If you tap (Ⓜ) the message will clear but the reminder icon (⚠) will display, and the message will reappear in 10 days.

## 11.7 Locking the Spa

From the Settings Menu (Figure A), tap **Locks** to enter the programming options, Figure B. You can prevent users from changing certain features of the spa. When a lock feature is active, the lock icon  will appear on the Main Menu.

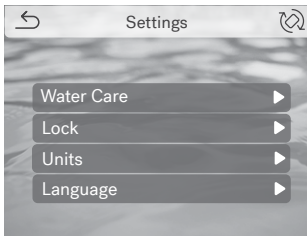

Figure A

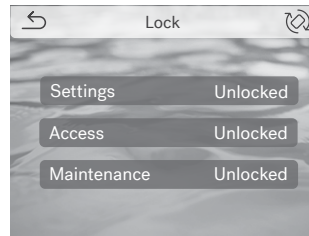



Figure B

### A. Settings Lock (Figure C):

1. Tap **Settings Unlocked** to enter the lock feature.
2. Scroll through each column to select a number. Then move on to the next number until a four-digit code has been selected.
3. Tap  to accept and save the change. The display will return to the Locks Menu.
4. The Settings Menu and all its functions are disabled, but the spa will still perform all scheduled tasks.
5. Tap  twice to return to the Main Menu.

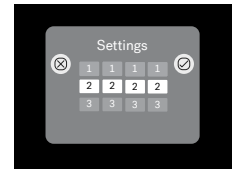

Figure C

### B. Access Lock (Figure D):





1. Tap **Access Unlocked** to enter the lock feature.
2. Scroll through each column to select a number. Then move on to the next number until a four-digit code has been selected.
3. Tap  to accept and save the change. The display will return to the Locks Menu.
4. All activation and adjustment features are disabled but the spa will still perform all scheduled tasks.
5. Tap  twice to return to the Main Menu.



Figure D

### C. Maintenance Lock (Figure E):

1. Tap **Maintenance Unlocked** to enter the lock feature.
2. Scroll through each column to select a number. Then move on to the next number until a four-digit code has been selected.
3. Tap  to accept and save the change. The display will return to the Locks Menu.
4. All spa functions are locked to allow for a temporary service mode such as filter cleaning.
5. Tap  twice to return to the Main Menu.

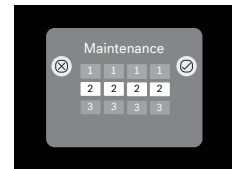



Figure E

**Note:** This mode has a time out of 2 hours. The spa should not be left in this lock mode for an extended period. Especially in colder climate or when freezing conditions exist.

## J-300

### D. To Unlock (Figure F):

1. Enter the Lock menu. Select the tab for the features to unlock settings, access or maintenance.
2. Scroll through each column to select a number. Then move on to the next number until a four-digit code has been entered.
3. Tap  to accept the code. The display will return to the Locks Menu.
4. Tap  twice to return to the Main Menu.

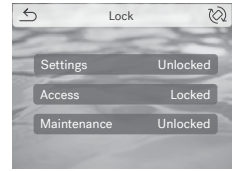



Figure F

**Note:** A default passcode can be used in case the original passcode is lost or forgotten. The code “0772” will unlock the locked setting.

## 11.8 Unit Display

From the Settings Menu (Figure A), tap  to enter the selection options, Figure B.

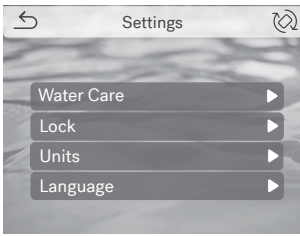

Figure A

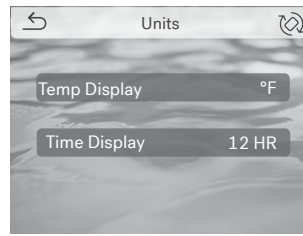





Figure B

1. Tap  to switch between °F or °C.
2. Tap  to switch between 12-HR or 24-HR format.
3. Tap  twice to return to the Main Menu.

## 11.9 Programming the Language

From the Settings Menu (Figure A), tap  to enter the selection options, Figure B.

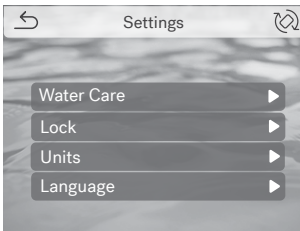

Figure A

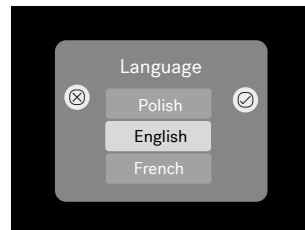



Figure B

1. There are 10 languages to select from: English, French, Spanish, German, Italian, Czech, Swedish, Norwegian, Finnish, and Polish.
2. To select a language, scroll through and select the language you want to display.
3. Tap  twice to return to the Main Menu.

### 11.10 Programming the Panel

From the Settings Menu (Figure A), tap **Panel** to enter the selection options, Figure B.

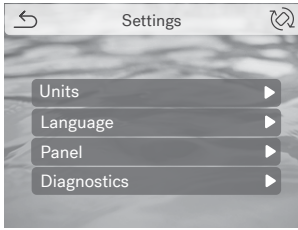

Figure A

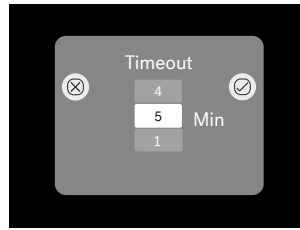



Figure B

1. Program how long the display stays active before going to sleep. Scroll through and select the number of minutes. The range is one to five minutes.
2. Tap  to accept the change. The display will return to the Settings Menu.
3. Tap  to return to the Main Menu.
4. To wake the display, tap the screen. The menu below will appear. Press the one then press the two.



### 11.11 Diagnostic Menu

From the Settings Menu (Figure A), tap **Diagnostics** to enter the selection options, Figure B.

**Note:** Most of the information provided in this menu is to assist a qualified technician troubleshoot the system.

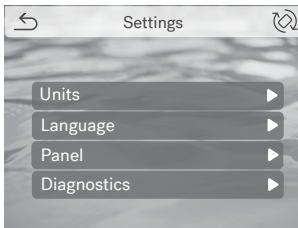

Figure A

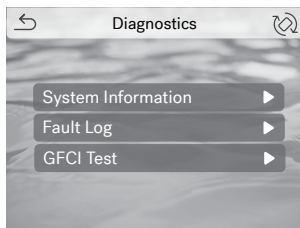

Figure B

1. **System Information:** Displays various system information about the hot tub. This information is helpful when servicing the hot tub.
2. **Faults:** Displays any faults detected by the hot tub. It will store up to 50 fault settings.
3. **GFCI Test:** It will perform a test for the GFCI breaker.

## J-300

### A. GFCI Test:

1. Tap **GFCI Test** to enter the feature, Figure C.
2. Tap **Test** to test the GFCI, Figure D.
3. The test will begin, Figure E.
4. The result will return either a pass or fail message.

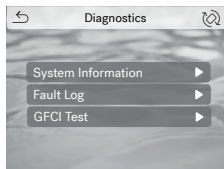

Figure C



Figure D

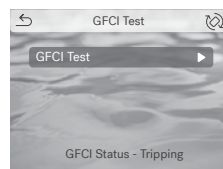

Figure E

### 11.12 Programming the Optional True™ Water Care Filtration

To access the Filtration Menu, press **True™**, Figure A, to enter the True™ Water Care Menu, Figure B. During a filtration, The True™ Water Care cycle activates the circulation pump, ozone, and air pump. The factory default cycle starts at 12:00 AM and last for 8 hours. If you elect to keep this setting, then you can skip this section.

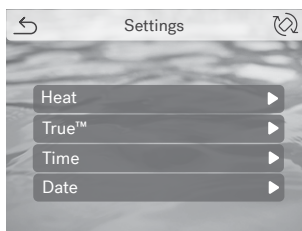

Figure A

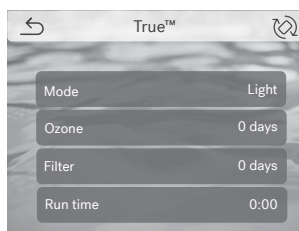

Figure B

#### A. 24-hour Mode:

The circulation pump and True™ Water Care System are always active. Time and duration cannot be altered for the cycle.

- System runs 24-hours.

#### B. Light Mode (default cycle):

The factory default cycle starts at 12:00 a.m. and provides 8 hours of filtration. Time and duration cannot be altered for the cycles, but you can change the start time.

- Factory default cycle starts at 12:00 a.m.
- 8 hours of primary filtration per day (2 hours at 12 a.m., 6 a.m., 12 p.m., 6 p.m.). The circulation pump and True™ Water Care System are active.
- 4 purge cycles (15-minute purge runs at the end of each cycle). The circulation and air pump are active.

**C. Medium Mode:**

The factory default cycle starts at 12:00 a.m. and provides 12 hours of filtration. Time and duration cannot be altered.

- Factory default cycle starts at 12:00 a.m.
- 12 hours of primary filtration per day (2 hours at 12 a.m., 4 a.m., 8 a.m., 12 p.m., 4 p.m., 8 p.m.). The circulation pump and True™ Water Care System are active.
- 6 purge cycles (10-minute purge runs at the end of each cycle). The circulation and air pump are active.



**D. Heavy Mode:**

The factory default cycle starts at 12:00 a.m. and provides 8 hours of filtration. Time and duration cannot be altered.





- Factory default cycle starts at 12:00 a.m.
- 16 hours of primary filtration per day (2 hours at 12 a.m., 3 a.m., 6 a.m., 9 a.m., 12 p.m., 3 p.m., 6 p.m., 9 p.m.). The circulation pump and True™ Water Care System are active.
- 4 purge cycles (7.5-minute purge runs at the end of each cycle). The circulation and air pump are active.

**E. Cycle Start Time**

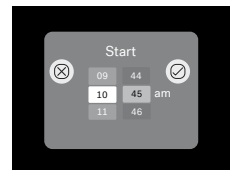
The factory default cycle starts at 12:00 a.m. but can be changed. Press **Start**  to enter the menu.

1. Scroll through the first column to change the hour in 1-hour increments. You cannot adjust the minutes column.
2. To select am or pm, you will need to round a 12-hour period.
3. Tap  to accept and save the change.
4. Tap  twice to return to the Main Menu.

**F. Additional Information Displayed**

1. Displays the number of days left for True™ Ozone unit before a replacement is needed, **Ozone**  .
2. Displays the number of days left for True™ Air Filter unit before a replacement is needed, **Filter**  .
3. Displays the amount of time the True™ Water Care System has been activated, **Run Time**  .
4. Displays the start time that the True™ Water Care System will run for the cycles programmed under the Mode tab, **Start**  .

**11.13 Programming the Optional True Water Care Reminders**

From the Settings Menu, tap **Water Care** (▶) to enter the Water Care Menu, Figures A and B. Then select one of the features.

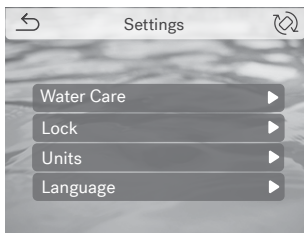

Figure A

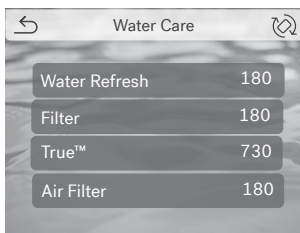

Figure B

**A. Programming the Water Refresh Timer**

A programmable Water Refresh reminder can be set to remind you when to drain and refill the spa. Tap **Water Refresh 180** (Figure B) to enter the Programming Menu.

1. From the Water Care Menu, you can set the Water Refresh timer, Figure C.
2. Scroll through the column to change to change the days in 30-day increments. The range is from OFF (- - -) to 180 days. It is not recommended that this feature be turned OFF. To continually maintain the water healthy and clean, in addition to chemical maintenance, it should be program as instructed.

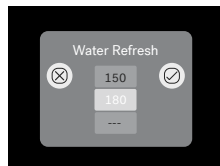

Figure C

**Note:** Pressing (X) will clear current changes made. The days will return to the previous programmed setting. This feature can be used to make corrections.

3. Tap (checkmark) to accept and save the change. The display will return to the Water Care Menu.
4. Tap (back arrow) twice to return to the Main Menu.
5. When the timer expires, a message will appear on the control panel display. The water must be drained and replaced with fresh water. Tap (refresh) and follow the instructions above to reset the timer. If you tap (Z) the message will clear but the reminder icon (warning triangle) will display and the message will reappear in 10 days.

**B. Programming the Filter Timer**

A programmable filter timer can be set to remind you when to clean or replace the filters. Tap **Filter** (▶) (Figure B) to enter the Programming Menu.

1. From the Water Care Menu, you can set the Filter timer, Figure D.
2. Scroll through the column to change the days in 10-day increments. The range is from OFF (- - -) to 180 days. It is not recommended that this feature be turned OFF. To continually maintain clean and working filters, it should be program as instructed.

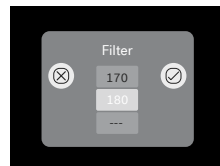







Figure D



**Note:** Pressing  will clear current changes made. The days will return to the previous programmed setting. This feature can be used to make corrections.

3. Tap  to accept and save the change. The display will return to the Water Care Menu.
4. Tap  twice to return to the Main Menu.
5. When the timer expires, a message will appear on the control panel display. The filter must be cleaned or replaced. Tap  and follow the instructions above to reset the timer. If you tap  the message will clear but the reminder icon  will display, and the message will reappear in 10 days.

**C. Programming the True™ Ozone Timer**





A programmable timer can be set to remind you when to replace the True™ Ozone unit. Tap  (Figure B) to enter the Programming Menu.

1. From the Water Care Menu, you can set the True™ Ozone timer, Figure E.
2. Scroll through the column to change the days in 30-day increments. The range is from OFF (- - -) to 730 days. It is not recommended that this feature be turned OFF. To continually maintain clean and working filters, it should be program as instructed.



Figure E

**Note:** Pressing  will clear current changes made. The days will return to the previous programmed setting. This feature can be used to make corrections.

3. Tap  to accept and save the change. The display will return to the Water Care Menu.
4. Tap  twice to return to the Main Menu.
5. When the timer expires, a message will appear on the control panel display. The True™ Ozone must be replaced. Tap  and follow the instructions above to reset the timer. If you tap  the message will clear but the reminder icon  will display, and the message will reappear in 10 days.

**D. Programming the Air Filter Timer**

A programmable timer can be set to remind you when to replace the True™ Air Filter. Tap  (Figure B) to enter the Programming Menu.





1. From the Water Care Menu, you can set the True™ Air Filter timer, Figure F.
2. Scroll through the column to change the days in 10-day increments. The range is from OFF (- - -) to 180 days. It is not recommended that this feature be turned OFF. To continually maintain a working Air Filter, it should be program as instructed.



Figure F

## J-300

**Note:** Pressing  will clear current changes made. The days will return to the previous programmed setting. This feature can be used to make corrections.

3. Tap  to accept and save the change. The display will return to the Water Care Menu.
4. Tap  twice to return to the Main Menu.
5. When the timer expires, a message will appear on the control panel display. The Air Filter must be replaced. Tap  and follow the instructions above to reset the timer. If you tap  the message will clear but the reminder icon  will display, and the message will reappear in 10 days.

## 12.0 Spa Maintenance

Proper and regular maintenance of your spa will help it retain its beauty and performance. Your authorized Jacuzzi dealer can supply you with all the information, supplies, and accessory products you will need to accomplish this.



### **DANGER: RISK OF SEVERE INJURY OR DROWNING BY ENTRAPMENT!**

- Keep hair, loose articles of clothing or hanging jewelry away from suction fittings, rotating jets or other moving components to avoid entrapment that could lead to drowning or severe injury.
- Never use the spa unless all suction guards, filter, filter lid, or skimmer assembly are installed to prevent body and/or hair entrapment.
- Never operate or use the spa if the filter, filter lid, or skimmer assembly are broken or any part of the skimmer assembly is missing. Please contact your dealer or nearest service center for service.
- The suction fittings and suction covers in this spa are sized to match the specific water flow created by the pump(s). If it is necessary to replace the suction fittings, suction covers or pump(s), be sure that the flow rates are compatible and are in compliance with the VGB Safety Act, page 2.
- Never replace a suction fitting or suction cover with one rated less than the flow rate marked on the original suction fitting. Using improper suction fittings or suction covers can create a body or hair suction entrapment hazard that may lead to drowning or severe injury.
- Owners must alert all spa users to the potential risk of Hair, Limb, Body, Evisceration (disembowelment), and Mechanical Entrapment, page 6.

## 12.1 Cleaning The Filters

Your Jacuzzi spa is equipped with a skimmer bag and two high performance pleated filter cartridges located under the filter cover. The circulation pump drawing water through the skimmer bag and filter cartridge filters fine debris. Large debris is filtered by jets pump 1 drawing water through the skimmer bag and second filter cartridge during an automated Secondary Filtration Cycle or when jets pump 1 is manually activated during spa use. Combined, both filters provide unsurpassed water quality by trapping surface oils and suspended particles. The filter cartridge should be cleaned once a month or as necessary, depending on use, for optimum performance.

An optional chemical feeder is available through your authorized Jacuzzi dealer that installs under the filter cap (#2472-673). Always remove the chemical feeder cap and feeder (when used) during the filter cleaning process by turning the cap handle counterclockwise. Reinstall the cap and feeder back onto the filter cartridge after the filter cleaning process is complete. It is recommended that latex gloves be used to avoid touching the chemical feeder during the filter cleaning process.

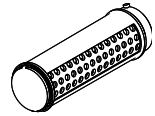

**Note:** When used, the chemical feeder **MUST** remain on the primary filtration filter cartridge! This filter cartridge is the one closest to the front of the spa.

### **TO DECREASE RISK OF DEATH, DROWNING OR ENTRAPMENT, ALWAYS TURN POWER TO SPA OFF BEFORE CLEANING THE FILTER CARTRIDGES!**

**Note:** Refer to steps on following page for complete filter cleaning/replacement instructions. Make sure to remove the Spa Frog cartridge holder prior to removing the filter (if equipped).



**DANGER: TURN POWER TO SPA OFF! TO DECREASE RISK OF DEATH, DROWNING, OR ENTRAPMENT, NEVER OPERATE SPA WHEN FILTER IS NOT PROPERLY INSTALLED OR IF SKIMMER ASSEMBLY IS DAMAGED OR ALTERED!**



**B**

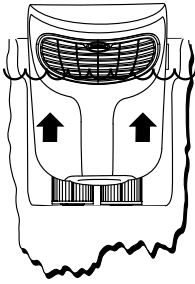

Lift upward on filter cover to remove it from the mating retaining clips. Then tilt forward to access filter cartridges.

**C**

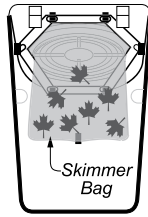

(Filter Cover Back View)

Remove skimmer bag from clips, then clean out debris.

**D**

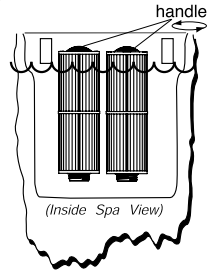

(Inside Spa View)

Rotate each filter cartridge counterclockwise to unthread from mating wall fitting.

**E**

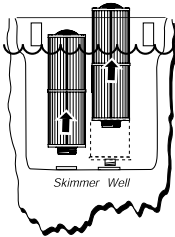

Skimmer Well

Lift unthreaded filter cartridge from skimmer well.

**F**

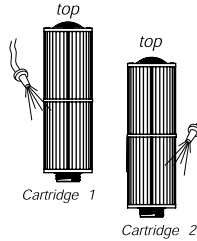

If used, remove the chemical feeder as instructed prior to rinsing the filter cartridges. Rinse debris from filter pleats on each cartridge using a garden hose and high pressure nozzle. Start at the top and work downward towards handle. Repeat until all pleats are clean.

**G**

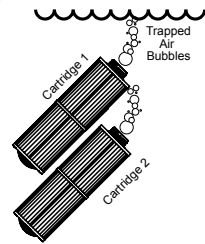

Submerge both filter cartridges in spa. Tilt threaded end upward to remove trapped air bubbles, then keep cartridges submerged to prevent air entrapment during installation (step H).

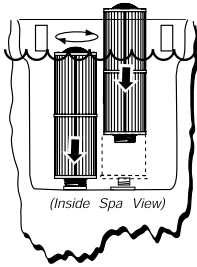
**H**

Place each cartridge back into skimmer well, then rotated each cartridge handle clockwise to thread back into wall fitting. **DO NOT OVERTIGHTEN!**

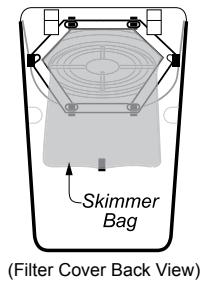
**I**

Install clean skimmer bag back onto the filter cover clips as shown.

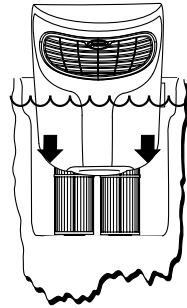
**J**

Tilt filter cover back then gently press down to latch against retaining clips. Turn power to spa back on.

Periodically, the filter cartridge will need a more thorough cleaning to remove imbedded oils and minerals. For this, we suggest cleaning followed by soaking the filter overnight in a plastic container filled with a solution of water and specially formulated filter cleanser available from your authorized Jacuzzi dealer. The average life expectancy of each filter is approximately two years with proper care and water quality maintenance. Replacement cartridges may be purchased from your authorized Jacuzzi dealer.

## 12.2 Draining and Refilling

About every 3 months, you will want to replace the spa's water. The frequency depends on a number of variables including the amount of use, attention paid to water quality maintenance, etc. You will know it is time for a change when you cannot control sudsing and/or you can no longer get the normal feel or sparkle to the water even though the key water balance measurements are all within the proper parameters.

**CAUTION! READ THIS BEFORE DRAINING:** To prevent damage to the spa's components, turn off power to the spa at the circuit breaker before draining it. Do not turn the power back on until your spa has been refilled.

**CAUTION:** There are certain precautions to keep in mind when draining your spa. If it is extremely cold, and the spa is outdoors, freezing could occur in the lines or the equipment, see "WINTERIZING" (page 54). On the other hand, if it is hot outdoors, do not leave the spa's surface exposed to direct sunlight.

## J-300

### To drain your spa, perform the following steps:

1. Turn off power to spa at breaker.
2. Locate the drain valve on the front/lower plastic pan. Hold the larger (rear) body to prevent it from turning, then loosen and remove the front cap to expose the underlying male hose threads.
3. Attach a garden hose to the exposed threads.
4. Gently rotate the larger (rear) valve body 1/3 turn counterclockwise to unlock the drain valve.
5. Pull the larger (rear) body outward to open drain.
6. After the spa drains, perform steps 2-5 in reverse order to close the drain prior to refilling the spa.

1. Turn off power to spa.

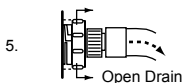
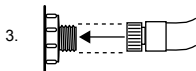
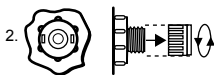

After refilling, turn on power to the spa and follow the steps listed under “Spa Fill Up Procedure” (page 19). If an airlock occurs, see troubleshooting section page 64.

### 12.3 Pillow Care

Remove and clean the headrest pillows as needed with soapy water using a cloth or soft-bristle brush. Always remove the pillows when adding chemical shock treatment to the spa water (except for the HydroSoothe™ pillow). The pillows can be returned to the spa when the sanitizer reading is stable as recommended on the inside cover of the manual.

**Note: The HydroSoothe™ pillow cannot be removed from the front. Do not pull the pillow.** The mounting hardware for the HydroSoothe™ pillow is different from the standard pillow. Reference to page 24 for the pillow location.

To remove **standard** pillows:

1. Grasp pillow (A) with finger tips and gently pry outward from pillow base (B).
2. Assemble in reverse order after cleaning.

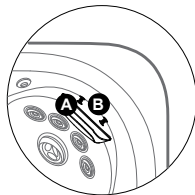

### 12.4 Cleaning The Spa Interior

To preserve the sheen of your spa's surface, it is crucial that you avoid using abrasive cleaners or cleaners which have adverse chemical effect on the surface. If you are not certain as to the suitability of a particular cleanser, consult your authorized Jacuzzi dealer. Regardless of the cleanser used, use extreme care to assure that no soap residue is left on the surface. This could cause severe sudsing when the spa is refilled.

## 12.5 Cover Care and Maintenance

Covers distributed by Jacuzzi Hot Tubs have PROLAST™/PROLAST™ Extreme encasement. The PROLAST™/PROLAST™ Extreme encasement also referred to as the cover “skin” is attractive and durable. Regular monthly cleaning is strongly recommended and may increase the longevity of your cover. Jacuzzi chemicals are for use in the U.S. only.

**Note:** It is highly recommended that you DO NOT put the seam over the control panel. This will cause premature failure of the control system.

### A. To Clean the Cover

1. Use a garden hose to loosen debris and dirt.
2. Using a large sponge or a soft bristle brush, use diluted or mild soap and scrub the top.
3. Rinse clean and do not allow soap to dry on cover. Do not use soap on the underside of the cover.
4. Do not use solvents, abrasive cleaners or strong detergents. Do not use products that contain silicone or alcohol.

### B. Additional Care and Maintenance Instructions:

1. Debris can accumulate on the spa cover. Removal of snow or other debris will help to avoid breakage of the foam cores.
2. Be sure to lock the cover straps to secure the cover from unwanted or accidental entry.
3. Do not place heavy objects on the cover.
4. Do not walk, sit or stand on the cover.
5. Do not drag or use the flaps/skirt or the cover lock straps to remove the cover.
6. Use only recommended cover lift systems.
7. Use only chemicals and cleaners recommended by Jacuzzi.
8. Remember to keep spa covered when not in use. Maintaining proper water levels assures efficient operation and efficient electrical usage.
9. Do not expose your spa to the sun for extended periods of time as UV rays can damage the interior surface.
10. Use caution when removing cover. Before removing cover, assure all locks have been released to avoid lock breakage and or cover strap damage.

## J-300

### 12.6 Tool Free Access Door

The Tool Free Access door provides fast access to the equipment bay and components without the need of tools. To remove the door, follow the steps below.

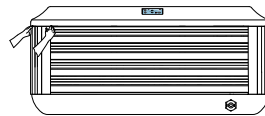

Figure 1

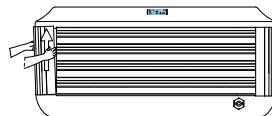

Figure 2

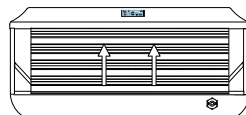

Figure 3

1. Grab one of the corner panels, from the top, where it touches the shell. Then gently pull the panel forward to unsnap it from the holding clips, Figure 1. Tilt the panel forward and then lift to remove, Figure 2. Place the panel in a safe location to prevent from damaging it. Repeat the steps to remove the other corner panel.

**Note:** The corner exterior lights on the panels are connected to the light wires. Take care when removing the corner panels to avoid damaging the wires.

2. Grab the bottom of the front panel and slightly lift to release it from the top mount. Tilt the panel and pull down to remove, Figure 3. Place the panel in a safe location to prevent from damaging it.

3. To reinstall the panel just follow the steps above in reverse order.

**Note:** Exposure of the cabinet to heat could cause the cabinet to warp. Should the cabinet warp, once it is installed, the warping is not visible. However, it does make the removal and replacement a little more challenging.

### 12.7 Maintaining the Spa Cabinet

Your new spa's cabinet requires little or no maintenance of any kind. To clean, simply wipe cabinet with a clean towel and mild soap solution.



**CAUTION:** Never spray cabinet with a garden hose for any reason since this action may induce an electrical short in the spa's electrical equipment.

### 12.8 Winterizing

Your Jacuzzi spa is designed to automatically protect itself against freezing when operating properly. During periods of severe freezing temperatures, you should check periodically to be certain that the electrical supply to the spa has not been interrupted. **In extreme bitter cold weather, less than 32°F (0°C), program the primary filtration cycle to run for 24 hours to prevent freezing (page 36).**



If you do not intend to use your spa, or if there is a prolonged power outage during periods of severe freezing temperatures, **it is important that all water be removed from the spa and equipment to protect against damage from freezing.**



**Expert winterization of your spa is highly recommended, contact your authorized Jacuzzi dealer.** In emergency situations, damage can be **minimized** by taking the following steps:

**CAUTION: TURN OFF POWER TO HOT TUB!**

1. Turn off power to the spa.
2. Follow the directions on page 51 for draining the spa.
3. Turn the massage/diverter selector(s) into the middle combo position to allow the water in the plumbing lines to drain, page 30.
4. Turn the HydroSoothe™ pillow and waterfall valve(s) to the open position to allow the water in the plumbing lines to drain, page 30.
5. Open all the air controls and leave them open until you resume use of the spa, page 31.
6. As the water level drops below the seats, use whatever means necessary to get the water out of the recessed seating areas and into the footwell, such as a wet/dry vacuum.
7. When the water level ceases to drop, use whatever means available to remove any remaining water from the foot well, such as a wet/dry vacuum.
8. Remove the synthetic cabinet panel under the control panel and locate the drain plugs on the front of the pump(s), (Figure A, page 16). Remove plugs to allow water to drain out of pumps and heater.  
**Note:** Approximately one to two gallons will be released during this procedure. Use a wet/dry vacuum or other means to keep this from flooding the equipment compartment. Replace the drain plugs.
9. Loosen the hose clamp on the circulation pump intake behind the control box (Figure A, page 16) and pull the hose off (twist hose back and forth while pulling outward). Tip hose down and allow to drain, then reinstall hose and clamp.
10. Loosen hose clamp at bottom of ClearRay® unit and pull hose off ClearRay® fitting (twist the hose back and forth while pulling downward). Tip hose down and allow to drain. Then reinstall hose and clamp. Remove the cover of the ClearRay® unit to access the UV bulb and quartz tube. Remove and store the UV bulb in a safe location. Remove and dry off the quartz tube then reinstall it. Depending on the length of time, consider replacing the UV bulb when you resume use of your hot tub.
11. Reinstall synthetic cabinet side panel and cover spa so that no casual moisture can enter it.

Consult your authorized Jacuzzi dealer if you have any questions regarding winter use or winterizing.

### 12.9 Restarting Your Spa in Cold Weather

If you want to start up your spa after it has sat empty for a time in freezing temperatures, be aware that the water remaining in certain sections of the piping may still be frozen. This situation will block water flow preventing the spa from operating properly and possibly damaging the equipment. We recommend you consult your authorized Jacuzzi dealer for guidance before attempting to restart your spa under these conditions.

### 13.0 Water Quality Maintenance

To decrease the risk of contracting a waterborne illness (e.g. an infection, bacteria or virus) and/or respiratory ailments, maintain water quality within specified limits. This will enhance your enjoyment and prolong the life of the hot tub's equipment. Doing so requires regular attention because the water chemistry involved is a balance of several factors. Procrastination regarding water maintenance will result in poor and potentially unhealthful conditions for soaking and even damage to your hot tub investment. For specific guidance on maintaining water quality, consult your Authorized Jacuzzi dealer who can recommend appropriate chemical products for sanitizing and maintaining your hot tub.



#### **WARNING: FAILURE TO MAINTAIN WATER QUALITY WILL:**

- Increase risk of contracting a waterborne illness (e.g. an infection bacteria or virus) and/or respiratory ailments.
- Damage the equipment, components and spa shell, which are not covered under the hot tub's warranty.

**CAUTION:** Never store hot tub chemicals inside the hot tub's equipment bay. The equipment bay may reach elevated temperatures, this is where high voltage electronic devices are located. This area is not intended for storage of any kind.

### 13.1 pH Control

pH is a measure of relative acidity or alkalinity of water and is measured on a scale of 0 to 14. The midpoint of 7 is said to be neutral, above which is alkaline and below which is acidic. In spa water, it is very important to maintain a slightly alkaline condition of 7.4 to 7.6 pH. Problems become proportionately severe the further outside of this range the water gets. A low pH will be corrosive to metals in the spa equipment. A high pH will cause minerals to deposit on the interior surface (scaling). In addition, the ability of the sanitation agents to keep the spa clean is severely affected as the pH moves beyond the ideal range. That is why almost all spa water test kits contain a measure for pH as well as the sanitizer.

### 13.2 Sanitizing

To destroy bacteria and organic compounds in the spa water, a sanitizer must be used regularly. Chlorine and bromine are the two most popular sanitizers used to date. The “Proclear Mineral Spa Clarifier” designed especially for your hot tub is a beneficial product for water maintenance. Many other additives are available for your spa. Some are necessary to compensate for out-of-balance water; some aid in cosmetic water treatment and others simply alter the feel or smell of the water. Your authorized Jacuzzi dealer can advise you on the use of these additives. When adding spa shock (chlorine or non-chlorine) or pH balancing chemicals activate the jets pump(s) and leave the spa cover open for a minimum of 20 minutes. By doing this you will allow excessive chemical vapors to exit the spa, protecting pillows and plastic knobs from chemical attack.



#### **WARNING: RISK OF PERSONAL INJURY, DROWNING OR ENTRAPMENT!**

Never leave your hot tub unattended for any reason while the cover is open and accessible, especially to small children and animals!

#### **CAUTION: RISK OF PERSONAL INJURY OR SPA DAMAGE!**

Never add chlorine tablets (trichlor) or acid to your hot tub for any reason! These chemicals may damage components within your hot tub, burn or irritate your skin, create a rash and void the manufacturer warranty for your spa.

### 13.3 ClearRay Active Oxygen® System

Your new hot tub has the ClearRay Active Oxygen® System installed. The ClearRay Active Oxygen® System is an exclusive technology utilizing ultraviolet light and ozone technology to help keep your water clean\*. The ballast is the power supply for the ClearRay Active Oxygen® System; it has two LED indicator lights, the green indicating incoming power flow and the red indicating the system is properly working. ClearRay Active Oxygen® is standard for all models.

**Note:** This system will not be installed if you have the optional True™ Water Care System.

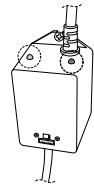

\*Clean is defined as the removal of microscopic (to 30 µm level) debris from the water. Ozone aids in the grouping of small debris. Once combined, the debris can be more easily caught by the filtration process.

## J-300

After a year the bulb must be replaced. A message will appear on the LCD display when the time allotted has expired. In order to clear the message, a new UV bulb needs to be installed, and the timer must be reset (page 62).



### WARNINGS:

- Do not operate the UV-C emitter when it is removed from the appliance enclosure.
- This appliance contains a UV-C emitter.
- Unintended use of the appliance or damage to the housing may result in the escape of dangerous UV-C radiation. UV-C radiation may, even in little doses, cause harm to the eyes and skin.
- Appliances that are obviously damaged must not be operated.
- Read the maintenance instructions before opening the appliance.

### 13.4 ClearRay® Bulb Replacement and Quartz Tube Maintenance

**Important:** It is **MANDATORY** that the UV bulb is replaced, and the quartz tube be cleaned every 12 months to maintain optimum performance.

Note: This will not be installed if you have the optional True™ Water Care System.

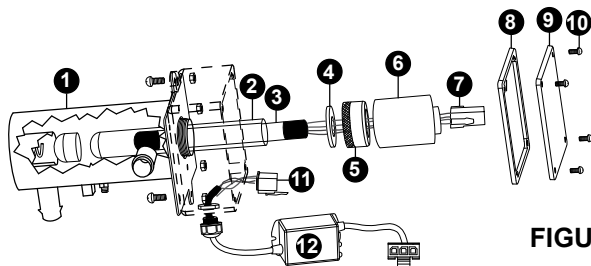

FIGURE 1



**DANGER:** TURN THE SPA BREAKER TO THE OFF POSITION!



**DANGER:** DRAIN THE SPA IF YOU ARE REPLACING OR CLEANING THE QUARTZ TUBE!



**WARNING:** ALLOW LAMP TO COOL DOWN PRIOR TO REMOVING FROM QUARTZ TUBE.



**DANGER:** NEVER LOOK AT THE LIT BULB. THIS CAN CAUSE SEVERE EYE DAMAGE OR BLINDNESS.

### UV BULB REPLACEMENT AND QUARTZ TUBE MAINTENANCE:

**Note:** Location of ClearRay System and connection may vary by model.

1. Turn the breaker to the spa OFF. **DRAIN YOUR SPA.**

**Note:** If you are only replacing the UV bulb then the spa does not have to be drained. You will need to drain it if you are replacing or cleaning the quartz tube.

2. Once the UV bulb has cooled off remove the ClearRay System enclosure cover (9) and gasket (8) by removing the four screws (10). This will expose the UV bulb and connections, Figure 2.

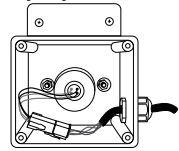

FIGURE 2



**DANGER:** NEVER REMOVE COVER WITHOUT FIRST TURNING OFF AT POWER SOURCE AND DRAINING THE SPA.

FIGURE 3

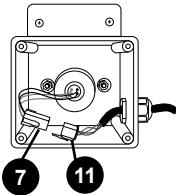

FIGURE 4

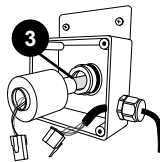

FIGURE 5

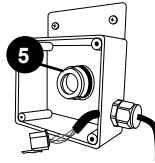
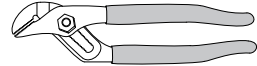

FIGURE 6



3. Disconnect UV bulb socket (7) from the power cord socket (11), Figure 3.

4. Slowly remove the UV bulb (3) out of the quartz tube, Figure 4.

5. Remove the quartz seal compression nut (5) by turning it **counterclockwise**, Figure 5. Use a pair of channel-lock pliers if needed, Figure 6. You will notice that there is a stainless-steel compression washer (4) which slides over the quartz tube, save the washer (4) for later use, Figure 7.

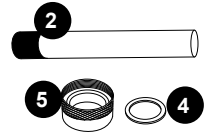

FIGURE 7

6. Now you are ready to clean or replace the quartz tube (2). For cleaning the quartz tube (2), follow steps 7 and 8 then proceed from step 9. For replacing quartz tube (2), skip steps 7 and 8 and proceed from step 9.

7. **Cleaning quartz tube:** Clean the quartz tube by wiping, until clear, using a paper towel or a dry cotton cloth. If needed, a household tub and shower lime removal product can be used.



**WARNING:** Do not use abrasive cleaners as they can scratch the quartz tube surface.

8. Rinse the quartz tube with clean water to completely remove any cleaning products that were used in step 7.

9. **Replacing quartz tube:** You will notice that the new quartz tube does not have a black cushion on the domed end as the old quartz tube does. This is normal as the cushion was provided with the original quartz tube to protect it from breakage during transportation. Place the new quartz tube (2) into the water chamber (1) with the

## J-300

- domed end first making sure it is inserted and seated inside the quartz end holder. Only a small portion will be exposed when it is seated correctly.
10. Reinstall the compression washer (4) over the open end of the quartz tube (2).
  11. Reinstall and hand tighten the quartz seal compression nut (5) by turning it **clockwise**.
  12. Refill your spa.
  13. **System Test 1:** Assure there is no water dripping from the seal compression nut (5). If water is visible, STOP and tighten the compression nut (5) using a pair of channel lock pliers to a maximum of 1/4 turn. If that does not fix the leak, then repeat quartz tube maintenance process from step 1 through step 12. Make sure there is no water leaking before proceeding to step 14.
  14. **System Test 2:** Reconnect the ClearRay unit to the controller. Turn breaker back ON. Turn on the pump to circulate the water through the ClearRay System. Wait for 5 minutes and assure no water is dripping. If water is visible, STOP, fix the leak by repeating quartz tube maintenance process from step 1 through step 13. **Make sure there is no water visible. Turn the pump and breaker OFF BEFORE proceeding to step 15.**
  15. Reconnect the UV bulb socket (7) to the power cord socket (11) make sure you use the latex glove provided when handling the UV bulb.



**WARNING: DO NOT TOUCH THE NEW UV BULB WITH YOUR BARE HAND.** Oil on your skin will cause hot spot on the UV bulb and shorten the life of your UV bulb. Use the provided latex glove to handle the UV bulb.

16. Slide the new UV bulb (3) back inside the quartz tube.
17. Reinstall the black bulb boot (6) back over the quartz seal compression nut (5).
18. Reinstall the enclosure cover (9) with gasket (8) and secure with the screws.
19. Properly dispose of the old UV bulb.



**WARNING:** This ClearRay System includes a UV bulb, which contains mercury. Dispose of the bulb in accordance with disposal laws. See [www.lamprecycle.org](http://www.lamprecycle.org).

20. Once power is activated you can check the ballast (12), Figure 8, to see if the ClearRay unit is functioning; it has two LED indicator lights the green indicating incoming power flow and the red indicating the system is properly working.

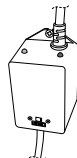

**FIGURE 8**

## 14.0 Error Conditions/Error Messages

Your spa has a self-diagnostic control system. The system will automatically display the following if a problem is detected. **Always insist on genuine Jacuzzi replacement parts.**

1. Freeze (Code 1): Possible freeze condition.
2. Sensor Balance Transient (Code 15): Sensors are out of sync.
3. Heat Low Flow (Code 15): The water flow is low.
4. Failed Flow (Code 17): The water flow has failed.
5. RTC Failure (Code 20): The clock has failed.
6. Persistent Memory Fail (Code 21): The settings have been reset.
7. Checksum Failure (Code 22): Program memory failure.
8. Config Error (Code 23): Configuration error. Contact your authorized dealer or service organization.
9. Sensor Balance Latch (Code 26): Sensor are out of sync. Contact your authorized dealer or service organization.
10. Heater Dry (Code 27): The heater is dry.
11. Heater Maybe Dry (Code 28): The heater maybe dry.
12. Spa Overheat (Code 29): **DO NOT ENTER THE WATER!** Spa water temperature above acceptable limits. Spa water is too hot.



**WARNING: RISK OF HYPERTHERMIA (OVER-HEATING)  
CAUSING SEVERE INJURY, BURNS, OR WELTS.**

13. Heater Overheat (Code 30): **DO NOT ENTER THE WATER!** The heater is too hot.



**WARNING: RISK OF HYPERTHERMIA (OVER-HEATING)  
CAUSING SEVERE INJURY, BURNS, OR WELTS.**

14. Sensor Fault A (Code 31): Sensor A fault. Contact your dealer or service organization.
15. Sensor Fault B (Code 32): Sensor B fault. Contact your dealer or service organization.
16. Stuck (Code 34): A pump may be stuck.

## J-300

17. Hot (Code 35): Hot fault. Contact your authorized dealer or service organization.
18. GFCI Failure (Code 36): The GFCI test failed.
19. Rest Mode Temp (Code 38): Run Jets 1 to get temperature.
20. Beta Version (Code 39): Test software is installed.
21. Set Time (Code 40): Set the time.
22. J29 Shorted (Code 44): J29.
23. Heatpump Comm Lost (Code 68): The Clim8zone has stopped communicating.
24. Heatpump Fault (Code 69): The Clim8zone reported an internal fault.
25. Heatpump Defrosting (Code 70): The Clim8zone is defrosting.
26. Heatpump Stuck On (Code 71): The Clim8zone did not turn off.
27. Heatpump Stuck Off (Code 72): The Clim8zone did not turn on.
28. Heatpump Flow Fault (Code 73): The Clim8zone reported a flow fault.
29. Heatpump Unexpected Shutoff (Code 74): The Clim8zone turned off.
30. Heater Authentication Error (Code 80): The heater authentication has failed. Could be caused by a bad chip on the heater or expander board.

31. ClearRay Replacement Reminder: This message will appear when the ClearRay bulb reminder time has expired (Figure A). The ClearRay bulb must be replaced. Displays for models equipped with the ClearRay Active Oxygen® only.

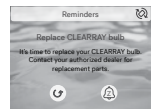

Figure A

32. Filter Reminder: This message will appear when the spa pleated filters reminder time has expired (Figure B). Remove the filters for cleaning or replacement. Displays for models equipped with the ClearRay Active Oxygen® or True™ Water Care System.

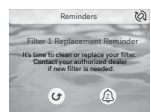

Figure B

33. Air Filter Reminder: This message will appear when the True™ Air Filter reminder time has expired (Figure C). The True™ Air Filter must be replaced. Displays for models equipped with the True™ Water Care System only.

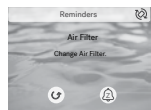

Figure C



34. Water Refresh Reminder: This message will appear when the Water Refresh timer has expired (Figure D). The water needs to be drained and refilled with fresh water. Displays for models equipped with the ClearRay Active Oxygen® or True™ Water Care System.

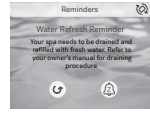

Figure D

35. Ozone Reminder: This message will appear when the Ozone timer has expired (Figure E). The water needs to be drained and refilled with fresh water. Displays for models equipped with the True™ Water Care System only.

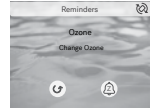

Figure E

36. Extended Temperature Activated: The spa is set to go up to 104°F (40°C), but it can be set to reach 106°F (41°C). To access the extended temperature, you need to set the temperature to 104°F (40°C). The press and hold your finger over the temperature reading for about 3 seconds. The temperature reading will turn white, and the Up button will start flashing, Figure F. This indicates the system is ready. Tap ^ to raise the temperature up to 105°F (40.5°C), press again to reach 106°F (41°C).



Figure F

**Note:** The Up button will continuously blink to indicate that the feature is active.



**WARNING: RISK OF HYPERTHERMIA (OVER-HEATING) CAUSING SEVERE INJURY, BURNS, WELTS OR DEATH!**

Water temperature in excess of 104°F (40°C) may be injurious to your health.

### 15.0 Troubleshooting Procedures

In the event your Jacuzzi spa is not working the way it should, please first review all the installation and operating instructions in this manual and check for messages on the panel display. If you are still not satisfied it is working properly, please follow the appropriate troubleshooting instructions below. **Always insist on genuine Jacuzzi replacement parts.**

**Note:** If any of the supply cords to accessories are damaged, they must be replaced by authorized service personnel. Contact your authorized Jacuzzi dealer or qualified service technician.

#### 15.1 Flow issues

1. Turn power off!
2. Verify water level is above all jets but below lowest pillow. Add water if necessary.
3. Check for clogged or dirty filter cartridge (Sec. 12.1, page 49).
4. Purge “air lock” from circulation pump intake by removing filter cartridge. Hold your garden hose over the filter cartridge wall fitting while using a rag as a seal around hose end. Ask a helper to turn on water for 30 seconds, then turn off. Reinstall filter cartridge and check spa (Sec. 12.1, page 49).
5. If the circulation pump is not running, turn power off at the main breaker, then turn power back on.
6. If problem persists, contact your authorized Jacuzzi dealer.

#### 15.2 None of the Components Operate (e.g. Pump, Light)

Check the following:

1. Is there power to the spa?
2. Is the household circuit breaker tripped?
3. Contact your authorized Jacuzzi dealer or qualified service technician.

#### 15.3 Pump Does Not Operate

Press the JETS 1 button. If no water movement is detected, make sure power is going to the spa and check the water level. If this does not solve the problem, contact your authorized Jacuzzi dealer or qualified service technician. The main jets pump 1 operates but no water flows to jets.

Check the following:

1. Jets may all be closed. Verify all jets are in the open “on” position (Sec. 10.6, page 30).
2. Pump may not be properly primed. This can happen after the spa is drained and refilled. Press the JETS 1 button on the control panel several times, never leaving the motor running for more than 5 to 10 seconds at a time. Turn power off and let the air out of spa plumbing system by removing the filter cartridge (Sec. 12.1, page 49). Make certain you reinstall the filter cartridge before turning on spa power and restarting the jets pump 1.

**15.4 Poor Jet Action**

- Make sure all jets are in the full open “on” position (page 30).
- Press the JETS 1 button to make certain pump #1 is on.
- Verify all air controls are in the “on” (page 31).
- Check for dirty filter. Clean, if necessary (Section 12.1, page 49).

**15.5 Water is Too Hot**

Reduce thermostat setting.

**15.6 No Heat**

1. Check thermostat setting.
2. Keep the spa cover in place while heating.
3. Check the settings to see if your spa is in economy mode (page 37).

Should checking the above steps fail to correct the problem, please call your Jacuzzi Hot Tub dealer so that they may arrange service. We build the best spas in the industry. Nonetheless, we are always striving to improve the quality and features of our products.

Your input as a Jacuzzi spa owner is a cherished part of this process. If you have any comments or suggestions, or if you wish to be informed on any new products for your spa, please write to us.

**CONGRATULATIONS** on your good taste and welcome to the happiest and most relaxed family in the world!

## 16.0 Circuit Board Diagrams

### 16.1 J-335, J-345, J-355, J-365, J-375 and J-385 Dedicated Power Models (60 Hz)

This wiring diagram is used for 240V (60 Hz) dedicated power models.

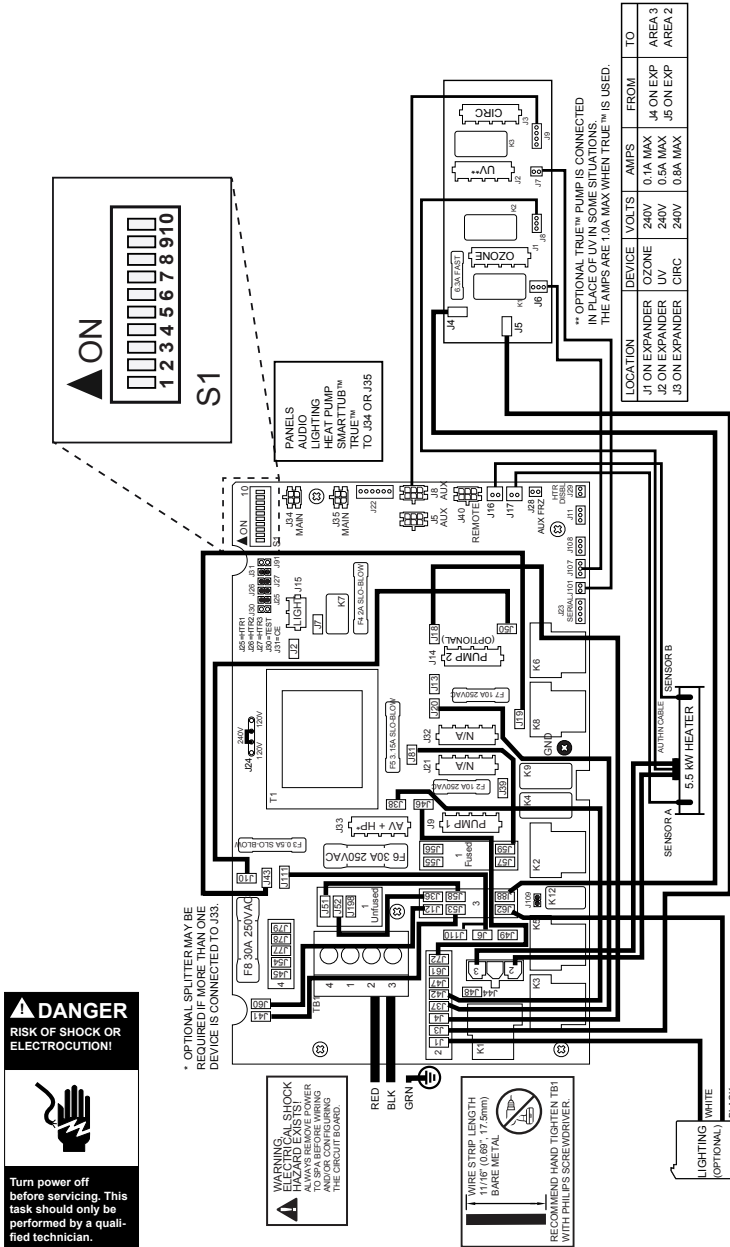

### 16.2 J-315 and J-325 3-Wire 240V 60Hz Dedicated Power Models

This wiring diagram is used for a 3-Wire 240V 60 Hz dedicated power models.

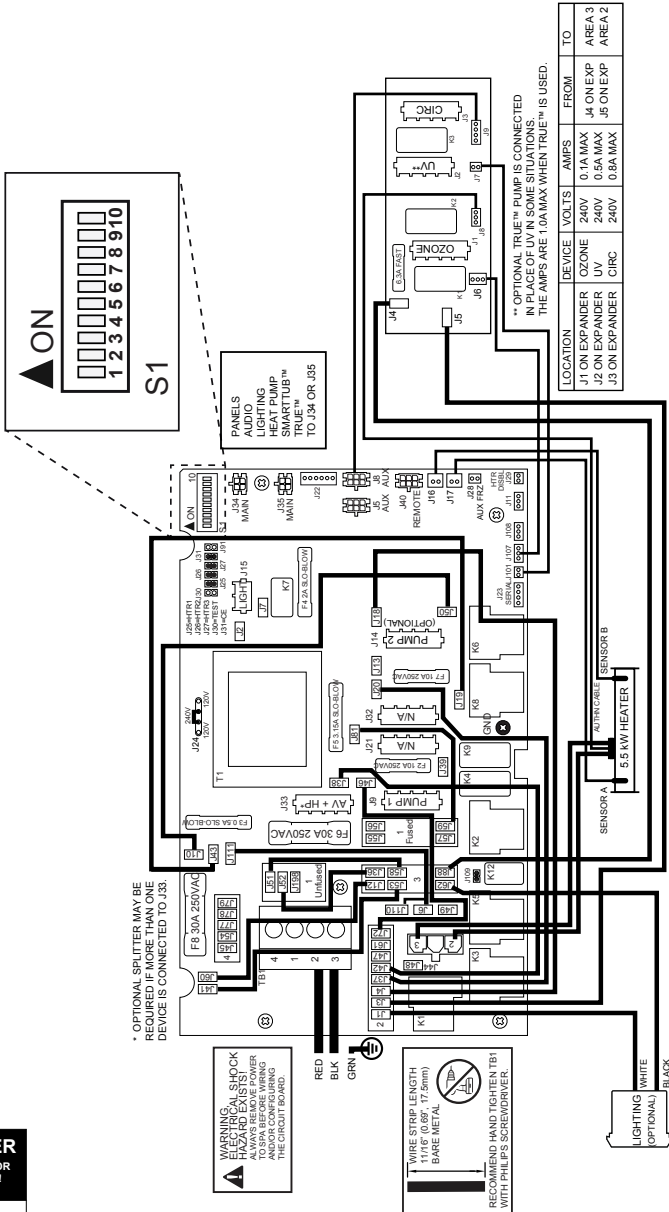

**⚠ DANGER**  
RISK OF SHOCK OR ELECTROCUTION!

Turn power off before servicing. This task should only be performed by a qualified technician.

**⚡ WARNING:** Determine the electrical requirements when working on J315 and J325 models. These models are available in a dedicated 240V 60Hz or 120V/240V 60Hz convertible configuration.



**16.4 J-315 and J-325 Convertible Power Models (For a 4-wire 240V 60 Hz connection)**

**CAUTION: THIS SECTION IS NOT APPLICABLE TO THE J315 AND J325 DEDICATED 3-WIRE 240V 60HZ MODELS.**

This wiring diagram is used for all North American 240V 60 Hz convertible power models. Converted 240V models must be permanently connected (hard-wired) to the power supply.

**Note:** 240 VAC 4-wire connection enhances heater output from 1kW to 4kW.

**⚠ DANGER**  
RISK OF SHOCK OR ELECTROCUTION!

Turn power off before servicing. This task should only be performed by a qualified technician.

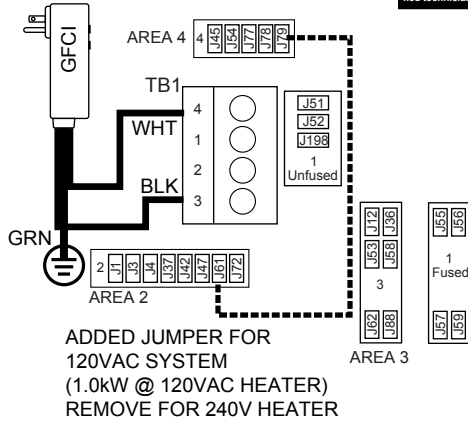
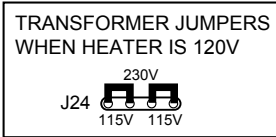

**FOR 240V HEATER:**

REMOVE JUMPER BETWEEN AREA 2 AND AREA 4 BEFORE REMOVING GFCI CORD AND CONNECTING A 30A 240VAC GFCI-PROTECTED SERVICE. THERE SHOULD BE NO WIRES GOING TO AREA 2 WHEN HEATER IS 240V.

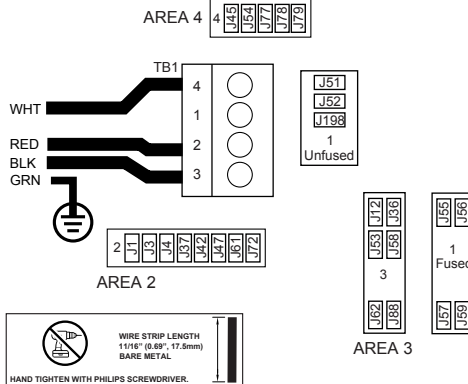
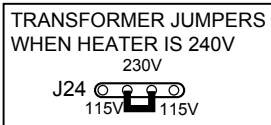

WIRE STRIP LENGTH  
1 1/16" (0.69", 17.5mm)  
BARE METAL

HAND TIGHTEN WITH PHILIPS SCREWDRIVER.

**NOTE:** 120V SERVICE IS LIMITED TO 12A (15A BREAKER) WHEN USING GFCI CORD. FOR 16A SERVICE (20A BREAKER), A WALL-MOUNTED GFCI MUST BE USED.

# J-300

## 17.0 Dip Switch Settings and Wiring

### 17.1 Switch settings for Domestic 60Hz Models

The dip switches are at the S1 location on the board.

#### A. J335 to J385 Models

OFF POSITION	S1 SWITCH	ON POSITION
TEST MODE OFF	◀ 1	TEST MODE ON
MUST BE OFF	◀ 2	N/A
SEE TABLE	◀ 3	SEE TABLE
SEE TABLE	4 ▶	SEE TABLE
MUST BE OFF	◀ 5	N/A
STORE SETTINGS**	◀ 6	MEMORY RESET**
MUST BE OFF	◀ 7	N/A
THERAPY LIGHT NOT PRESENT***	◀ 8	THERAPY LIGHT PRESENT***
TRUE™ NOT PRESENT****	◀ 9	TRUE™ PRESENT****
DEMO MODE OFF	◀ 10	DEMO MODE ON

\*\* SWITCH # 6 SHOULD BE SET TO OFF UPON FINAL INSTALLATION.

\*\*\* SWITCH # 8 SHOULD BE SET TO ON FOR THE IR THERAPY LIGHTS.

\*\*\*\* SWITCH # 9 SHOULD BE SET TO ON FOR THE TRUE™ WATER CARE SYSTEM.

BREAKER	DIP SWITCH NUMBER									
	1	2	3	4	5	6	7	8**	9***	10
40A	OFF	OFF	ON	OFF	OFF	OFF	OFF	OFF	OFF	OFF
50A*	OFF	OFF	OFF	ON	OFF	OFF	OFF	OFF	OFF	OFF
60A	OFF	OFF	ON	ON	OFF	OFF	OFF	OFF	OFF	OFF
*50A is the factory default setting										
**Dip Switch 8 is ON when the IR Therapy Lights are installed.										
***Dip Switch 9 is ON when the True™ Water Care System is installed.										

#### B. J315 and J325 3-Wire 240V Dedicated Models

BREAKER	DIP SWITCH NUMBER									
	1	2	3	4	5	6	7	8	9**	10
40A	OFF	OFF	ON	OFF	OFF	OFF	OFF	OFF	OFF	OFF
50A*	OFF	OFF	OFF	ON	OFF	OFF	OFF	OFF	OFF	OFF
*50A is the factory default setting										
**Dip Switch 9 is ON when the True™ Water Care System is installed.										



**WARNING:** Determine the electrical requirements when working on J315 and J325 models. These models are available in a dedicated 240V 60Hz or 120V/240V 60Hz convertible configuration.



C. J315 and J325 Convertible Models

OFF POSITION	S1 SWITCH	ON POSITION
TEST MODE OFF	◀ 1	TEST MODE ON
MUST BE OFF	◀ 2	N/A
SEE TABLE	◀ 3	SEE TABLE
SEE TABLE	◀ 4	SEE TABLE
SEE TABLE	5 ▶	SEE TABLE
STORE SETTINGS**	◀ 6	MEMORY RESET**
N/A	7 ▶	MUST BE ON
MUST BE OFF	◀ 8	N/A
TRUE™ NOT PRESENT	◀ 9	TRUE™ PRESENT
DEMO MODE OFF	◀ 10	DEMO MODE ON

\*\* SWITCH # 6 SHOULD BE SET TO OFF UPON FINAL INSTALLATION.  
 \*\*\*\* SWITCH # 9 SHOULD BE SET TO ON FOR THE TRUE™ WATER CARE SYSTEM.

BREAKER	DIP SWITCH NUMBER									
	1	2	3	4	5	6	7	8	9**	10
15A*	OFF	OFF	OFF	OFF	ON	OFF	ON	OFF	OFF	OFF
30A	OFF	OFF	ON	ON	OFF	OFF	ON	OFF	OFF	OFF
40A	OFF	OFF	OFF	OFF	OFF	OFF	ON	OFF	OFF	OFF

\*15A is the factory default setting (GFCI Cord)  
 \*\*Dip Switch 9 is ON when the True™ Water Care System is installed.



**WARNING:** Determine the electrical requirements when working on J315 and J325 models. These models are available in a dedicated 240V 60Hz or 120V/240V 60Hz convertible configuration.

## **18.0 Optional BLUEWAVE® Spa Stereo System**

To start enjoying your new stereo receiver, please read the following operation instructions in their entirety.





**WARNING: RISK OF ELECTRICAL SHOCK HAZARD EXISTS AND EQUIPMENT DAMAGE!** Never install or remove electrical devices (e.g. AUX/Bluetooth) while hands are wet or while sitting partially or fully immersed in the spa!

### **18.1 Electronic Device Connections and Functions**

#### **A. Connecting Your Bluetooth Device:**

1. From your Bluetooth device, make sure the Bluetooth setting is ON.
2. Follow the pairing instructions for your Bluetooth device and connect to the “AQUATIC AV” or “BLUEWAVE” device that appears on your screen.
3. If asked for a password, enter the code “0000.”
4. The remote LCD screen will display, “BT AUDIO” if the process was successful.
5. A second Bluetooth device can be paired but only one can be played at a time.

### **18.2 Stereo Cautions**

1.  **“CAUTION** - Risk of Electric Shock. Replace components only with identical components.”
2.  **“WARNING** - Risk of Electrocution. Do not connect any auxiliary components (for example cables, additional speakers, headphones, additional audio/video components, etc.) to the system.”
3. Do not service this product yourself as opening or removing covers may expose you to dangerous voltage or other risk of injury. Refer all servicing to qualified service personnel.
4. When the power supply connections or power supply cord(s) are damaged; if water is entering the audio/video compartment or any electrical equipment compartment area; if the protective shields or barriers are showing signs of deterioration; or if there are signs of other potential damage to the unit, turn off the unit and refer servicing to a qualified service personnel.





